



iQ SERIES

2500 Watt 2 Way 8"/10"/12"/15" Powered Loudspeaker

3000 Watt 15"/18" Powered Subwoofer

**KLARK TEKNIK DSP Technology, Speaker Modelling and
ULTRANET Networking**

Quickstart Guide



EN

EN

Important Safety Instructions

ES



Terminals marked with this symbol carry electrical current of sufficient magnitude to constitute risk of electric shock. Use only high-quality commercially-available speaker cables with plugs pre-installed. All other installation or modification should be performed only by qualified personnel.



This symbol, wherever it appears, alerts you to the presence of uninsulated dangerous voltage inside the enclosure - voltage that may be sufficient to constitute a risk of shock.



This symbol, wherever it appears, alerts you to important operating and maintenance instructions in the accompanying literature. Please read the manual.



Caution
To reduce the risk of electric shock, do not remove the top cover (or the rear section). No user serviceable parts inside. Refer servicing to qualified personnel.



Caution
To reduce the risk of fire or electric shock, do not expose this appliance to rain and moisture. The apparatus shall not be exposed to dripping or splashing liquids and no objects filled with liquids, such as vases, shall be placed on the apparatus.



Caution
These service instructions are for use by qualified service personnel only. To reduce the risk of electric shock do not perform any servicing other than that contained in the operation instructions. Repairs have to be performed by qualified service personnel.

1. Read these instructions.
2. Keep these instructions.
3. Heed all warnings.
4. Follow all instructions.
5. Do not use this apparatus near water.
6. Clean only with dry cloth.
7. Do not block any ventilation openings. Install in accordance with the manufacturer's instructions.
8. Do not install near any heat sources such as radiators, heat registers, stoves, or other apparatus (including amplifiers) that produce heat.

9. Do not defeat the safety purpose of the polarized or grounding-type plug. A polarized plug has two blades with one wider than the other. A grounding-type plug has two blades and a third grounding prong. The wide blade or the third prong are provided for your safety. If the provided plug does not fit into your outlet, consult an electrician for replacement of the obsolete outlet.

10. Protect the power cord from being walked on or pinched particularly at plugs, convenience receptacles, and the point where they exit from the apparatus.

11. Use only attachments/accessories specified by the manufacturer.



12. Use only with the cart, stand, tripod, bracket, or table specified by the manufacturer, or sold with the apparatus. When a cart is used, use caution when

moving the cart/apparatus combination to avoid injury from tip-over.

13. Unplug this apparatus during lightning storms or when unused for long periods of time.

14. Refer all servicing to qualified service personnel. Servicing is required when the apparatus has been damaged in any way, such as power supply cord or plug is damaged, liquid has been spilled or objects have fallen into the apparatus, the apparatus has been exposed to rain or moisture, does not operate normally, or has been dropped.

15. The apparatus shall be connected to a MAINS socket outlet with a protective earthing connection.

16. Where the MAINS plug or an appliance coupler is used as the disconnect device, the disconnect device shall remain readily operable.



17. Correct disposal of this product: This symbol indicates that this product must not be disposed of with household waste, according to the WEEE Directive (2012/19/EU) and your national law.

This product should be taken to a collection center licensed for the recycling of waste electrical and electronic equipment (EEE). The mishandling of this type of waste could have a possible negative impact on the environment and human health due to potentially hazardous substances that are generally associated with EEE. At the same time, your cooperation in the correct disposal of this product will contribute to the efficient use of natural resources. For more information about where you can take your waste equipment for recycling, please contact your local city office, or your household waste collection service.

LEGAL DISCLAIMER

MUSIC Group accepts no liability for any loss which may be suffered by any person who relies either wholly or in part upon any description, photograph, or statement contained herein. Technical specifications, appearances and other information are subject to change without notice. All trademarks are the property of their respective owners. MIDAS, KLARK TEKNIK, TURBOSOUND, BEHRINGER, BUGERA and DDA are trademarks or registered trademarks of MUSIC Group IP Ltd. © MUSIC Group IP Ltd. 2015 All rights reserved.

LIMITED WARRANTY

For the applicable warranty terms and conditions and additional information regarding MUSIC Group's Limited Warranty, please see complete details online at music-group.com/warranty.

Thank you for choosing a TURBOSOUND loudspeaker product for your application. If you would like further information about this or any other TURBOSOUND product, please visit our website at turbosound.com.

Unpacking the Loudspeaker

After unpacking the unit please check carefully for damage. If damage is found, please notify your supplier at once. You, the consignee, must instigate any claim. Please retain all packaging in case of future re-shipment.

Controls

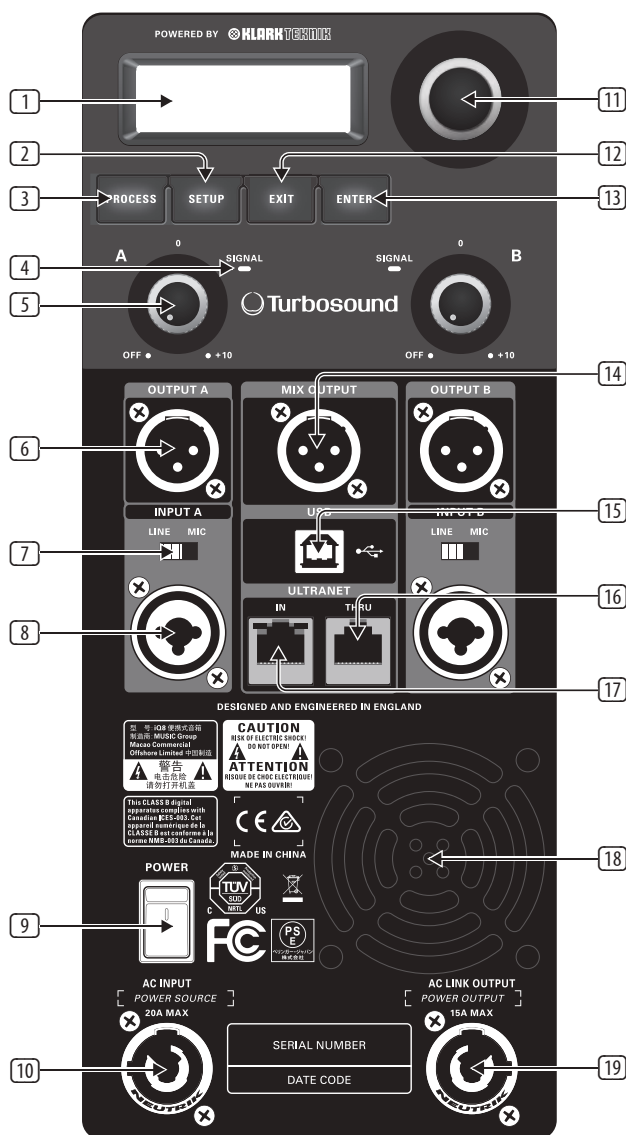

- ① **LCD SCREEN** displays the current DSP module and parameter settings.
- ② **SETUP** button steps through parameters within DSP processing modules.
- ③ **PROCESS** button steps through the DSP processing modules.
- ④ **SIGNAL LED** lights up to indicate the channel is receiving a signal.
- ⑤ **GAIN** controls adjusts the analogue input level. To increase signal gain, rotate the controls clockwise; to reduce the gain, rotate the knobs counter-clockwise. (Fullrange models have separate GAIN knobs for channels A and B, while iQ15B and iQ18B subwoofers have a single dedicated A/B knob for both channels.)
- ⑥ **OUTPUT A/OUTPUT B** XLR connectors provide un-processed copies of the INPUT A or INPUT B signals.
- ⑦ **LINE/MIC** switch adjusts the input sensitivity for INPUT A and INPUT B.
- ⑧ **INPUT A/INPUT B** combo jacks accept input signals using XLR, balanced ¼" TRS or unbalanced ¼" TS connectors.
- ⑨ **POWER** switch turns the unit on and off.
- ⑩ **AC INPUT** accepts power connections from power cables fitted with Neutrik powerCON twist-locking connectors.
- ⑪ **ENCODER KNOB** toggles between Graphic and Edit modes (when pressed) and changes parameter values (when rotated).
- ⑫ **EXIT** button returns to the top-level DSP screen when pressed.
- ⑬ **ENTER** button saves changes and deactivates Edit mode when pressed.
- ⑭ **MIX OUTPUT** XLR jack (unavailable on iQ15B and iQ18B subwoofers) sends out a post-GAIN signal composed of the summed INPUT A and INPUT B signals.
- ⑮ **USB** connection enables firmware updates and remote control over parameters via computer. Please visit turbosound.com to download DSP control software for your computer.
- ⑯ **ULTRANET THRU** sends out unprocessed digital audio from the ULTRANET IN connector to additional ULTRANET-equipped devices.
- ⑰ **ULTRANET IN** RJ45 plug comes with 2 linked green status LEDs. Whenever a CAT5 cable has been connected, and a valid ULTRANET signal is detected, both LEDs will light up simultaneously to indicate that the ULTRANET signal is ready to use.
- ⑱ **VENTILATION FAN** speed adjusts automatically to ensure trouble-free operation.
- ⑲ **AC LINK OUTPUT** connects power to other devices using power cables with Neutrik powerCON twist-locking connectors.

Networking capability

All iQ powered loudspeakers offer remote control via USB. The USB connection allows the user to configure and monitor all DSP parameters using dedicated iQ software for PC.

The DSP firmware can also be updated via the USB connection. Visit turbosound.com for the latest firmware version.

iQ speakers also offer proprietary ULTRANET networking capabilities through the ULTRANET IN and THRU connections using CAT5 cables with RJ45 connectors. ULTRANET allows the user to transmit unidirectionally up to 16 independent channels of 24-bit audio throughout the iQ system, as well as other ULTRANET-equipped devices such as digital mixers and personal monitor systems. Up to 7 devices can be connected in series on a single ULTRANET cable. ULTRANET can also be used for remote control of the iQ selection of modeled speakers.

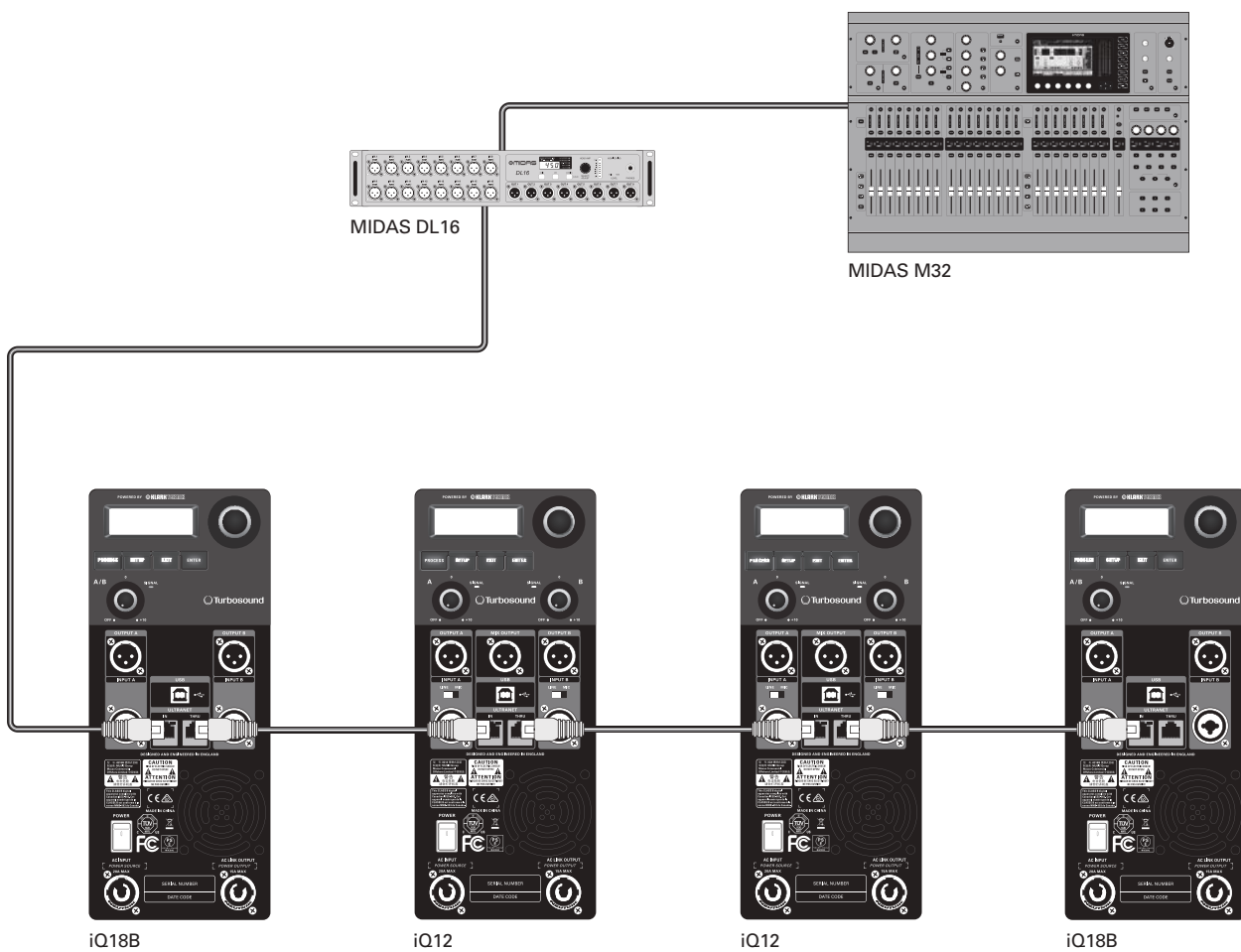

ULTRANET connection with MIDAS M32 digital mixer and MIDAS DL16 digital snake





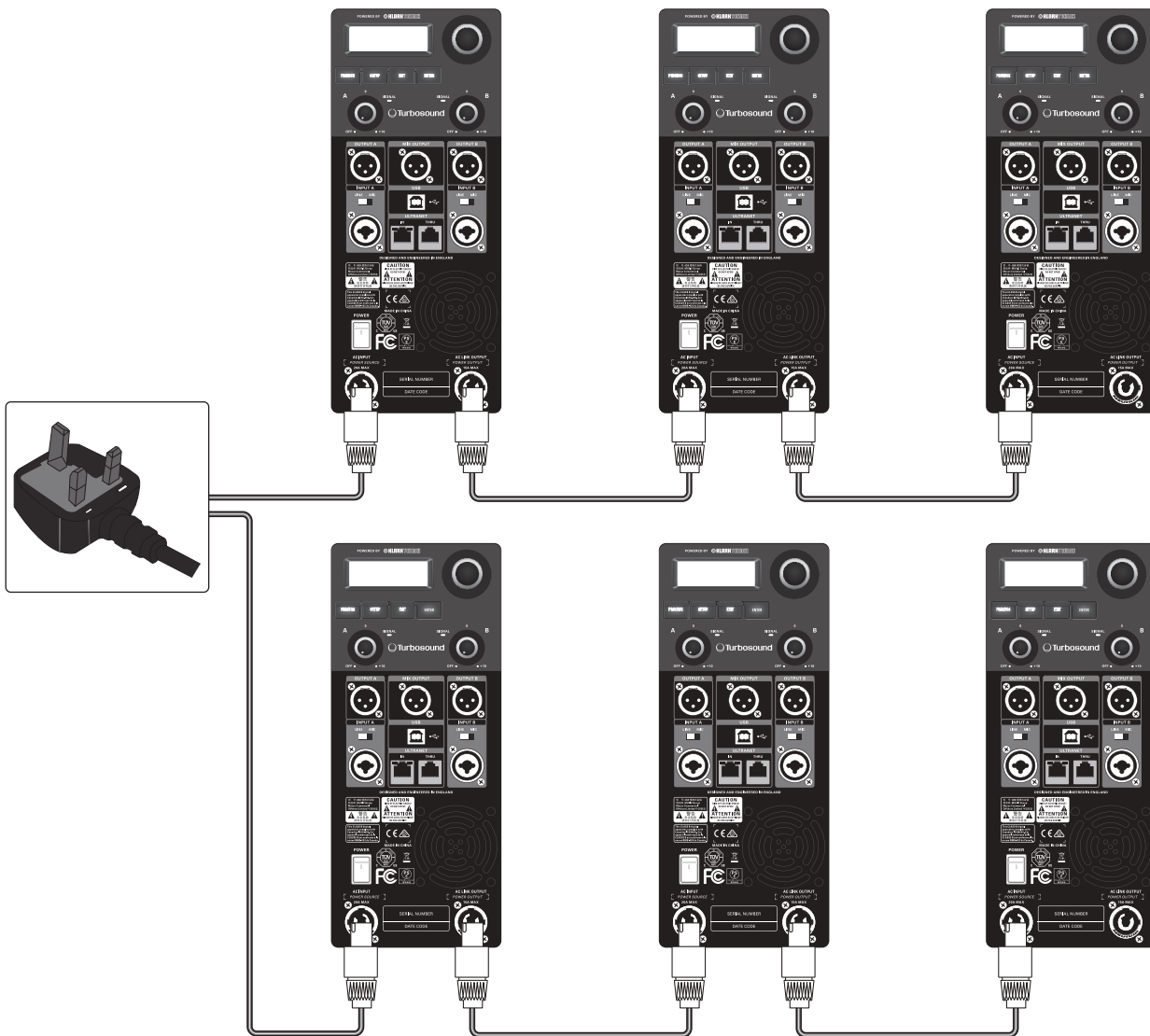

Networked mains power





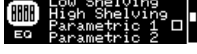

iQ loudspeakers also facilitate networked transmission of mains power using power cables with Neutrik powerCON locking power connectors. To set up networked mains power between iQ loudspeakers, first run a power cable terminating in a powerCON connector to the AC INPUT connector on the rear panel. To power additional speakers downline, run power cables equipped with powerCON connectors at both ends from the first speaker's AC LINK OUTPUT to the AC INPUT of the next iQ loudspeaker in series. The maximum number of linked systems depends on the AC supply voltage as well as the maximum current draw of the individual systems in the power chain. When linking a power chain, make sure that the integrated connectors as well as the supplied AC mains cable are never overloaded. If you are uncertain how to calculate the total current draw, please contact your dealer.







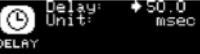

iQ speakers powered in series

iQ DSP Menu Structure

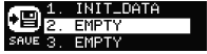
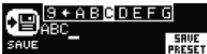
		Fullrange	Subwoofer	Function
 PROCESS	 MODEL	Model "xyz"	Model "xyz"	Choose from different sound Models, either the TURBOSOUND signature voicing or a DSP model of an industry standard product.
 (alt., MODEL active)	 EQ	None	None	Sets the frequency response to the default setting.
		Live	Live	Sets the frequency response to a typical live sound setting.
		Speech	Speech	Sets the frequency response for optimal speech intelligibility.
		Playback	Playback	Sets the frequency response ideal for music playback.
		User	User	Lets you define your own frequency response setting by entering the corresponding sub menu.
	 Sub menu	Low/ High Shelving	Low/ High Shelving	Lets you define a low and high shelving filter.
		Parametric 1 & 2	Parametric 1 & 2	Lets you define a parametric bell-type EQ (Frequency, Qual and Gain).
	 XOVER	None	None	Unit is set for default full range/ subwoofer reproduction.
		—	iQ8	Preset with ideal settings for use in combination with iQ8 fullrange speaker.
		—	iQ10	Preset with ideal settings for use in combination with iQ10 fullrange speaker.
		—	iQ12	Preset with ideal settings for use in combination with iQ12 fullrange speaker.
		—	iQ15	Preset with ideal settings for use in combination with iQ15 fullrange speaker.
		iQ15B	—	Preset with high pass alignment for iQ15B subwoofer.
		iQ18B	—	Preset with high pass alignment for iQ18B subwoofer.
		User	User	User crossover sub menu for combination with other fullrange or subwoofer speaker systems.
	 Sub Menu	Freq	Freq	Select the desired crossover frequency: For Fullrange Systems: 75 Hz to 400 Hz For Subwoofer Systems: 50 Hz to 150 Hz
		Phase	Phase	Adjust the absolute phase (0° or 180°)

		Fullrange	Subwoofer	Function
	 FBQ	Auto	Auto	Automatically sets as many filters as required. Whenever a new feedback frequency is discovered, the first filter will be released to attenuate the new frequency, and so forth.
		Single	Single	Activates the FBQ (feedback detection) functionality, up to 8 feedback filters.
		Learn	Learn	Automatic procedure which searches for feedback frequencies and locks settings after all 8 filters have been set. WARNING! Please use ear protection during this procedure. The feedback signal may approach the system's maximum level, which may cause hearing damage!
		Reset	Reset	Resets all filters.
 SETUP (page 1)	 INPUT	Input	Input	Lets you choose the audio input source. Chose between Local (Analogue Input) or ULTRANET (e.g., P16 monitoring system or M32 audio via ULTRANET).
	 Trim	Trim	Trim	Adjusts the input gain of the ULTRANET digital inputs in a range fm +10 dB to -30 dB
		Remote	Remote	Enables ULTRANET remote control functionality in order to protect against misuse.
		VU	VU	Displays the respective input level of all 16 channels receiving via ULTRANET; only visible when ULTRANET input is selected.
	 POSITION	Stand	Floor	For positioning the speaker on a pole mount stand (fullrange) or on the floor (subwoofer).
		Wall	Wall	For positioning the speaker on or next to a wall (fixed install); alternatively as a monitor speaker (wedge).
		Ceiling	—	For positioning the speaker on a wall next to the ceiling (fixed install).
		Corner	Corner	For positioning the speaker in a corner next to the ceiling (fixed install); For positioning the speaker in a corner (subwoofer).
	 DELAY	Delay	Delay	Adjusts the amount of delay (max 300msec = 103.08m or 338.19 feet).
		Unit	Unit	Selects between msec, meter and feet.
	 LIMITER	Limit	Limit	Adjust the limiter threshold for the input signal (from OFF up to -30 dB). This threshold adjustment allows you to set a max output power which is below the iQ system's rated max output.

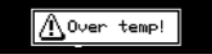
		Fullrange	Subwoofer	Function
 SETUP (page 2)		Version	Version	Displays the installed firmware version.
 LOAD	1. - 20.	1. - 20.	To load a specific preset, turn the encoder to select the desired preset's number, and then either the ENTER button or the encoder. When asked to confirm press the encoder again or EXIT to abort.	
 SAVE	1. - 20.	1. - 20.	To save a preset choose the respective preset slot and press ENTER or the encoder.	
 Sub Menu	Save Preset	Save Preset	Name the preset by choosing the characters with the encoder and pressing to confirm each character. When finished, press the ENTER button to save the preset.	
 Setup	Contrast	Contrast	Adjust LCD panel contrast. The default contrast value is 15.	
	Screen	Screen	ON: LCD screen saver (default) turns on automatically after approx. 2 minutes. OFF : LCD turns off automatically after approx. 5 minutes.	
	Logo	Logo	OFF: Deactivates front panel logo illumination. ON: Activates front panel logo illumination. LIMIT: Logo will light up when the limiter is active.	
 Sub Menu	Lock	Lock	Lock the device and create a password by choosing the password characters with the encoder and pressing to confirm each character. When finished press the ENTER button. Unlock the device by entering the password or connecting the unit via USB to a PC running iQ software. The software does not require a password.	
	Warning	Warning	In case of overheating, an alert appears on the LCD screen, and the amplifier will shut down until the unit cools.	

LCD Graphic Indicators

To help the user immediately recognize that a parameter has been selected and changed from the initial default setting, the parameter's related text on the top-level screen will invert and change to black text on a white background. As an example, the following screenshots show how the text for the MODEL function changes when the iQ8 default sound has been changed to the modeled PS8 sound:

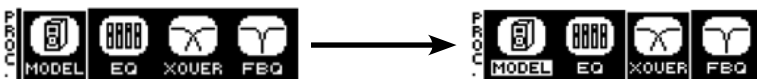

This indicator function occurs only on the main DSP menu level and works for all DSP-related functions, except for the LOAD, SAVE and SETUP sub-sections on the second page of the top-level SETUP menu.

Mounting and fixing

iQ series powered loudspeakers are designed with multiple internal rigging points to suit many possible mounting methods in permanent installations. All cabinets can be simply suspended using optional M10 eyebolts coupled to the internal rigging points provided on the top, bottom, sides and back. The simplest method is to use the two rigging points on the top and a single pull-back rigging point in the centre of the rear panel. Remove the appropriate plastic caps and insert eyebolts, which must have a thread length of at least 30 mm. Use the rear rigging point to angle the cabinet for optimum room coverage.

Wall and Ceiling Brackets

TURBOSOUND iQ8-WB, iQ10-WB, iQ12-WB and iQ15-WB wall and ceiling brackets are optionally available for iQ series.

The graphic below shows the assembly of the optional mounting brackets (iQ8-WB, iQ10-WB, iQ12-WB and iQ15-WB).

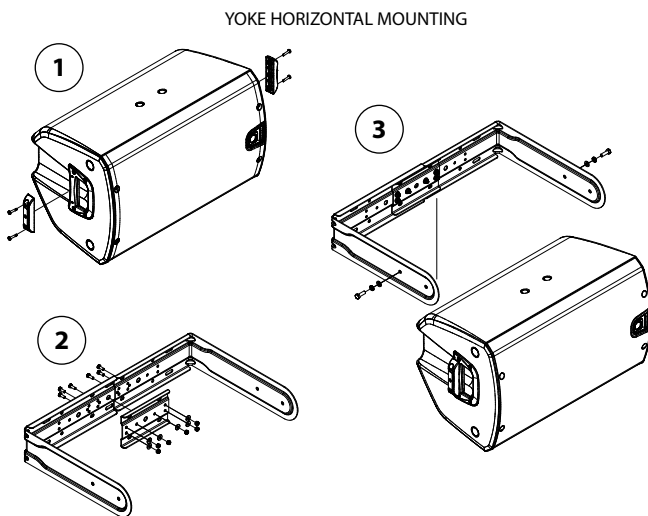

Step 1: Secure Yoke Spacers

ITEM	DESCRIPTION	QUANTITY
1	Yoke spacer	2
2	M5 x 25 mm screw with nylon thread locking	4

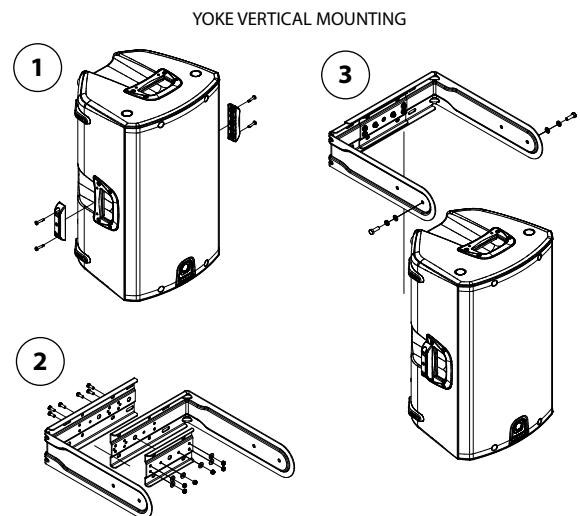

Step 2: Assemble Steel Yoke Bracket: iQ8 and iQ10

ITEM	DESCRIPTION	QUANTITY
1	Steel yoke bracket 1	1
2	Steel yoke bracket 2	1
3	M5 x 15 mm screw	2(iQ8) 4(iQ10)
4	M5 plain washer	2(iQ8) 4(iQ10)
5	M5 nylon locking nut	2(iQ8) 4(iQ10)

Step 2: Assemble Steel Yoke Bracket: iQ12 and iQ15

ITEM	DESCRIPTION	QUANTITY
1	Steel yoke bracket 1	1
2	Steel yoke bracket 2	1
3	Steel yoke bracket 3	1
4	M6 plain washer	6
5	M6 x 16 mm screw	6
6	M6 nylon locking nut	6

Step 3: Place Speaker Into Yoke Bracket

ITEM	DESCRIPTION	QUANTITY
1	Steel yoke bracket assembly	1
2	M8 x 25 mm screw	2
3	M8 plain washer	2
4	M8 spring lock washer	2

NOTE: For iQ8 and iQ10, the finished bracket requires only 2 pieces, while the iQ12 and iQ15 bracket requires 3 pieces.

Pole Mounting

Fullrange iQ loudspeaker models (iQ8, iQ10, iQ12 and iQ15) may also be pole mounted, either independently or in conjunction with iQ subwoofer models (iQ15B, iQ18B). The iQ pole mount sockets allow fullrange models to be mounted straight or angled 7.5° downwards for optimum coverage.

iQ10, iQ12 and iQ15 models may also be placed on one side and deployed as wedge monitors.

These models have been designed with sides angled at 48° to help with upward sound dispersion.

Transport

The subwoofers are supplied with castors for ease of transportation when used as a portable sound system.

To assemble the castors to the back of the cabinets, remove the 16 bolts from the rear of the speaker, align the castors with the mount holes and replace the bolts.

IMPORTANT NOTE: The mounting of a permanently installed sound system may be dangerous unless undertaken by qualified personnel with the required experience and certification to perform the necessary tasks. Walls, floors or ceilings must be capable of safely and securely supporting the actual load. The mounting accessory used must be safely and securely fixed both to the loudspeaker and to the wall, floor or ceiling.

When mounting rigging components on walls, floors or ceilings, ensure that all fixings and fasteners used are of an appropriate size and load rating. Wall and ceiling claddings, and the construction and composition of walls and ceilings, all need to be taken into account when determining whether a particular fixing arrangement can be safely employed for a particular load. Cavity plugs or other specialist fixings, if required, must be of an appropriate type, and must be fitted and used in accordance with the maker's instructions.

The operation of your speaker cabinet as part of a flown system, if installed incorrectly and improperly, can potentially expose persons to serious health risks and even death. In addition, please ensure that electrical, mechanical and acoustic considerations are discussed with qualified and certified (by local state or national authorities) personnel prior to any installation or flying.

Make sure that speaker cabinets are set up and flown by qualified and certified personnel only, using dedicated equipment and original parts and components delivered with the unit. If any parts or components are missing please contact your Dealer before attempting to set up the system.

Be sure to observe the local, state and other safety regulations applicable in your country. MUSIC Group, including the MUSIC Group companies listed on the enclosed "Service Information Sheet", assumes no liability for any damage or personal injury resulting from improper use, installation or operation of the product. Regular checks must be conducted by qualified personnel to ensure that the system remains in a secure and stable condition. Make sure that, where the speaker is flown, the area underneath the speaker is free of human traffic. Do not fly the speaker in areas that can be entered or used by members of the public.

Speakers create a magnetic field, even if not in operation. Therefore, please keep all materials that can be affected by such fields (discs, computers, monitors, etc) at a safe distance. A safe distance is usually between 1 and 2 metres.

EN Technical Specifications

	iQ8	iQ10	iQ12
System			
Frequency response	60 Hz – 18 kHz \pm 3 dB 55 Hz – 20 kHz -10 dB	55 Hz – 18 kHz \pm 3 dB 50 Hz – 20 kHz -10 dB	52 Hz – 18 kHz \pm 3 dB 45 Hz – 20 kHz -10 dB
Nominal dispersion	90° H x 90° V @ -6 dB points	90° H x 60° V @ -6 dB points	80° H x 60° V @ -6 dB points
Maximum SPL	128 dB peak	129 dB peak	130 dB peak
Crossover type	Active	Active	Active
Transducers	1 x 8" (208 mm) LF driver 1 x 1" (25.4 mm) HF compression driver	1 x 10" (256 mm) LF driver 1 x 1" (25.4 mm) HF compression driver	1 x 12" (308.5 mm) LF driver 1 x 1" (25.4 mm) HF compression driver
Limiter	Independent HF, LF, peak and rms	Independent HF, LF, peak and rms	Independent HF, LF, peak and rms
Amplifier			
Maximum output power*	2,500 W	2,500 W	2,500 W
Type	Class-D	Class-D	Class-D
Protection	Short circuit, open circuit, thermal	Short circuit, open circuit, thermal	Short circuit, open circuit, thermal
Connectors			
Input A / B	2 x combo jack/XLR	2 x combo jack/XLR	2 x combo jack/XLR
Sensitivity	Line +4 dBu, mic -22 dBu, switchable	Line +4 dBu, mic -22 dBu, switchable	Line +4 dBu, mic -22 dBu, switchable
Input impedance	20 k Ω unbalanced, 40 k Ω balanced	20 k Ω unbalanced, 40 k Ω balanced	20 k Ω unbalanced, 40 k Ω balanced
Maximum input level	+21 dBu	+21 dBu	+21 dBu
Output A / B	2 x XLR Linked to input	2 x XLR Linked to input	2 x XLR Linked to input
Mix output	XLR, balanced	XLR, balanced	XLR, balanced
Output impedance	100 Ω unbalanced, 200 Ω balanced	100 Ω unbalanced, 200 Ω balanced	100 Ω unbalanced, 200 Ω balanced
Ultranet input/link	2 x RJ45	2 x RJ45	2 x RJ45
Mains Supply	Neutrik powerCON input 20A and link 15A	Neutrik powerCON input 20A and link 15A	Neutrik powerCON input 20A and link 15A
Controls			
DSP	Rotary push-encoder Buttons for PROCESS, SETUP, EXIT, ENTER	Rotary push-encoder Buttons for PROCESS, SETUP, EXIT, ENTER	Rotary push-encoder Buttons for PROCESS, SETUP, EXIT, ENTER
Mixer section	2 x gain controls (channels A and B) 2 x Line/Mic switch	2 x gain controls (channels A and B) 2 x Line/Mic switch	2 x gain controls (channels A and B) 2 x Line/Mic switch
User DSP Functions			
Factory EQ presets	Positioning, Sound mode, Sound Modeling, FBQ	Positioning, Sound mode, Sound Modeling, FBQ	Positioning, Sound mode, Sound Modeling, FBQ
Display	LCD 128 x 32, blue backlit	LCD 128 x 32, blue backlit	LCD 128 x 32, blue backlit
Delay	0 - 300 ms	0 - 300 ms	0 - 300 ms
Equalisation	High and low shelving EQ 2 x parametric EQ	High and low shelving EQ 2 x parametric EQ	High and low shelving EQ 2 x parametric EQ
Limiter	Zero attack input limiter	Zero attack input limiter	Zero attack input limiter
Presets	20 total presets, 19 user-definable	20 total presets, 19 user-definable	20 total presets, 19 user-definable
Crossover	High Pass L-R 24 dB/oct	High Pass L-R 24 dB/oct	High Pass L-R 24 dB/oct
Protection	Lock-out function for all settings	Lock-out function for all settings	Lock-out function for all settings

	iQ8	iQ10	iQ12
Ultraset Digital Network			
System			
Signal Latency	16 channels < 0.9 ms	16 channels < 0.9 ms	16 channels < 0.9 ms
Cabling			
Cables Cable length	Shielded CAT5 max. 246 ft / 75 m recommended	Shielded CAT5 max. 246 ft / 75 m recommended	Shielded CAT5 max. 246 ft / 75 m recommended
Power Supply			
Power consumption	150 W @ 1/8 max power	150 W @ 1/8 max power	150 W @ 1/8 max power
Voltage (fuses)			
USA / Canada	120 V~, 60 Hz (T 15 A H 250 V)	120 V~, 60 Hz (T 15 A H 250 V)	120 V~, 60 Hz (T 15 A H 250 V)
UK / Australia / Europe	220-240 V~, 50/60 Hz (T 10 A H 250 V)	220-240 V~, 50/60 Hz (T 10 A H 250 V)	220-240 V~, 50/60 Hz (T 10 A H 250 V)
Korea / China	220-240 V~, 50/60 Hz (T 10 A H 250 V)	220-240 V~, 50/60 Hz (T 10 A H 250 V)	220-240 V~, 50/60 Hz (T 10 A H 250 V)
Japan	100 V~, 50/60 Hz (T 15 A H 250 V)	100 V~, 50/60 Hz (T 15 A H 250 V)	100 V~, 50/60 Hz (T 15 A H 250 V)
Enclosure			
Dimensions HWD	457 x 279 x 279 mm (18.0 x 11.0 x 11.0")	526 x 324 x 316 mm (20.7 x 12.7 x 12.4")	609 x 370 x 370 mm (24.0 x 14.5 x 14.5")
Net weight	14.7 kg (32 lbs)	17.2 kg (38 lbs)	21.1 kg (46 lbs)
Construction	Injection-moulded polypropylene enclosure	Injection-moulded polypropylene enclosure	Injection-moulded polypropylene enclosure
Finish	Black painted	Black painted	Black painted
Grille	Powder coated perforated steel	Powder coated perforated steel	Powder coated perforated steel
Flying hardware	M10 x 3 points	M10 x 3 points	M10 x 3 points
Accessories			
	IQ8-WB Steel wall bracket	IQ10-WB Steel wall bracket	IQ12-WB Steel wall bracket

EN Technical Specifications

	iQ15	iQ15B	iQ18B
System			
Frequency response	50 Hz – 18 kHz ± 3 dB 42 Hz – 20 kHz -10 dB	50 Hz – 130 Hz ± 3 dB 40 Hz – 130 Hz -10 dB	50 Hz – 100 Hz ± 3 dB 36 Hz – 100 Hz -10 dB
Nominal dispersion	75° H x 55° V @ -6 dB points	Half Space	Half Space
Maximum SPL	132 dB peak	130 dB peak	132 dB peak
Crossover type	Active	Active	Active
Transducers	1 x 1" (387 mm) LF driver 1 x 1" (25.4 mm) HF compression driver	1 x 15" (385.7 mm) LF driver	1 x 18" (460 mm) LF driver
Limiter	Independent HF, LF, peak and rms	Peak and rms	Peak and rms
Amplifier			
Maximum output power*	2,500 W	3,000 W	3,000 W
Type	Class-D	Class-D	Class-D
Protection	Short circuit, open circuit, thermal	Short circuit, open circuit, thermal	Short circuit, open circuit, thermal
Connectors			
Input A / B	2 x combo jack/XLR	2 x combo jack/XLR	2 x combo jack/XLR
Sensitivity	Line +4 dBu, mic -22 dBu, switchable	Line +4 dBu	Line +4 dBu
Input impedance	20 k Ω unbalanced, 40 k Ω balanced	20 k Ω unbalanced, 40 k Ω balanced	20 k Ω unbalanced, 40 k Ω balanced
Maximum input level	+21 dBu	+21 dBu	+21 dBu
Output A / B	2 x XLR Linked to input	2 x XLR Linked to input	2 x XLR Linked to input
Mix output	XLR, balanced	N/A	N/A
Output impedance	100 Ω unbalanced, 200 Ω balanced	N/A	N/A
Ultranet input/link	2 x RJ45	2 x RJ45	2 x RJ45
Mains Supply	Neutrik powerCON input 20A and link 15A	Neutrik powerCON input 20A and link 15A	Neutrik powerCON input 20A and link 15A
Controls			
DSP	Rotary push-encoder Buttons for PROCESS, SETUP, EXIT, ENTER	Rotary push-encoder Buttons for PROCESS, SETUP, EXIT, ENTER	Rotary push-encoder Buttons for PROCESS, SETUP, EXIT, ENTER
Mixer section	2 x gain controls (channels A and B) 2 x Line/Mic switch	1 x gain controls (channels A and B) 2 x Line	1 x gain controls (channels A and B) 2 x Line
User DSP Functions			
Factory EQ presets	Positioning, Sound mode, Sound Modeling, FBQ	Positioning, Sound mode, Sound Modeling, FBQ	Positioning, Sound mode, Sound Modeling, FBQ
Display	LCD 128 x 32, blue backlit	LCD 128 x 32, blue backlit	LCD 128 x 32, blue backlit
Delay	0 - 300 ms	0 - 300 ms	0 - 300 ms
Equalisation	High and low shelving EQ 2 x parametric EQ	High and low shelving EQ 2 x parametric EQ	High and low shelving EQ 2 x parametric EQ
Limiter	Zero attack input limiter	Zero attack input limiter	Zero attack input limiter
Presets	20 total presets, 19 user-definable	20 total presets, 19 user-definable	20 total presets, 19 user-definable
Crossover	High Pass L-R 24 dB/oct	Low Pass L-R 24 dB/oct	Low Pass L-R 24 dB/oct
Protection	Lock-out function for all settings	Lock-out function for all settings	Lock-out function for all settings

	iQ15	iQ15B	iQ18B
Ultraset Digital Network			
System			
Signal Latency	16 channels < 0.9 ms	16 channels < 0.9 ms	16 channels < 0.9 ms
Cabling			
Cables	Shielded CAT5	Shielded CAT5	Shielded CAT5
Cable length	max. 246 ft / 75 m recommended	max. 246 ft / 75 m recommended	max. 246 ft / 75 m recommended
Power Supply			
Power consumption	150 W @ 1/8 max power	200 W @ 1/8 max power	200 W @ 1/8 max power
Voltage (fuses)			
USA / Canada	120 V~, 60 Hz (T 15 A H 250 V)	120 V~, 60 Hz (T 15 A H 250 V)	120 V~, 60 Hz (T 15 A H 250 V)
UK / Australia / Europe	220-240 V~, 50/60 Hz (T 10 A H 250 V)	220-240 V~, 50/60 Hz (T 10 A H 250 V)	220-240 V~, 50/60 Hz (T 10 A H 250 V)
Korea / China	220-240 V~, 50/60 Hz (T 10 A H 250 V)	220-240 V~, 50/60 Hz (T 10 A H 250 V)	220-240 V~, 50/60 Hz (T 10 A H 250 V)
Japan	100 V~, 50/60 Hz (T 15 A H 250 V)	100 V~, 50/60 Hz (T 15 A H 250 V)	100 V~, 50/60 Hz (T 15 A H 250 V)
Enclosure			
Dimensions HWD	711 x 450 x 381 mm (27.9 x 17.7 x 15.0")	602 x 445 x 495 mm (23.7 x 17.5 x 19.5")	691 x 533 x 559 mm (27.2 x 21.0 x 22.0")
Net weight	26.1 kg (57 lbs)	30.6 kg (67 lbs)	39.8 kg (87.5 lbs)
Construction	Injection-moulded polypropylene enclosure	Birch plywood, screwed, and glued	Birch plywood, screwed, and glued
Finish	Black painted	Black painted	Black painted
Grille	Powder coated perforated steel	Powder coated perforated steel	Powder coated perforated steel
Flying hardware	M10 x 3 points	N/A	N/A
Accessories			
	IQ15-WB Steel wall bracket		

*independent of limiters and driver protection circuits

Other important information

EN Important information

- 1. Register online.** Please register your new MUSIC Group equipment right after you purchase it by visiting turbosound.com. Registering your purchase using our simple online form helps us to process your repair claims more quickly and efficiently. Also, read the terms and conditions of our warranty, if applicable.
- 2. Malfunction.** Should your MUSIC Group Authorized Reseller not be located in your vicinity, you may contact the MUSIC Group Authorized Fulfiller for your country listed under "Support" at turbosound.com. Should your country not be listed, please check if your problem can be dealt with by our "Online Support" which may also be found under "Support" at turbosound.com. Alternatively, please submit an online warranty claim at turbosound.com BEFORE returning the product.
- 3. Power Connections.** Before plugging the unit into a power socket, please make sure you are using the correct mains voltage for your particular model. Faulty fuses must be replaced with fuses of the same type and rating without exception.

FEDERAL COMMUNICATIONS COMMISSION COMPLIANCE INFORMATION

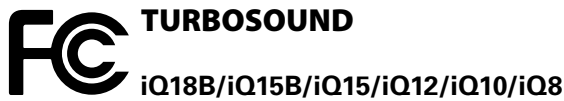

Responsible Party Name: **MUSIC Group Services NV Inc.**

Address: **5270 Procyon Street
Las Vegas, NV 89118 USA**

Phone Number: **+1 702 800 8290**

iQ18B/iQ15B/iQ15/iQ12/iQ10/iQ8

This equipment has been tested and found to comply with the limits for a Class B digital device, pursuant to part 15 of the FCC Rules. These limits are designed to provide reasonable protection against harmful interference in a residential installation. This equipment generates, uses and can radiate radio frequency energy and, if not installed and used in accordance with the instructions, may cause harmful interference to radio communications. However, there is no guarantee that interference will not occur in a particular installation. If this equipment does cause harmful interference to radio or television reception, which can be determined by turning the equipment off and on, the user is encouraged to try to correct the interference by one or more of the following measures:

- Reorient or relocate the receiving antenna.
- Increase the separation between the equipment and receiver.
- Connect the equipment into an outlet on a circuit different from that to which the receiver is connected.
- Consult the dealer or an experienced radio/TV technician for help.

This equipment complies with Part 15 of the FCC Rules. Operation is subject to the following two conditions:

- (1) This device may not cause harmful interference, and
- (2) This device must accept any interference received, including interference that may cause undesired operation.

Important information:

Changes or modifications to the equipment not expressly approved by MUSIC Group can void the user's authority to use the equipment.