

ALLEN & HEATH



MixWizard WZ³ 14:4:2

USER GUIDE

Publication AP5332

Limited One Year Warranty

This product is warranted to be free from defects in materials or workmanship for a period of one year from the date of purchase by the original owner.

To ensure a high level of performance and reliability for which this equipment has been designed and manufactured, read this User Guide before operating. In the event of a failure, notify and return the defective unit to ALLEN&HEATH Limited or its authorised agent as soon as possible for repair under warranty subject to the following conditions

Conditions Of Warranty

1. The equipment has been installed and operated in accordance with the instructions in this User Guide
2. The equipment has not been subject to misuse either intended or accidental, neglect, or alteration other than as described in the User Guide or Service Manual, or approved by ALLEN&HEATH.
3. Any necessary adjustment, alteration or repair has been carried out by ALLEN&HEATH or its authorised agent.
4. This warranty does not cover fader wear and tear.
5. The defective unit is to be returned carriage prepaid to ALLEN&HEATH or its authorised agent with proof of purchase.
6. Units returned should be packed to avoid transit damage.

In certain territories the terms may vary. Check with your ALLEN&HEATH agent for any additional warranty which may apply.



This product complies with the European Electromagnetic Compatibility directives 89/336/EEC & 92/31/EEC and the European Low Voltage Directives 73/23/EEC & 93/68/EEC.

This product has been tested to EN55103 Parts 1 & 2 1996 for use in Environments E1, E2, E3, and E4 to demonstrate compliance with the protection requirements in the European EMC directive 89/336/EEC. During some tests the specified performance figures of the product were affected. This is considered permissible and the product has been passed as acceptable for its intended use. Allen & Heath has a strict policy of ensuring all products are tested to the latest safety and EMC standards. Customers requiring more information about EMC and safety issues can contact Allen & Heath.

NOTE: Any changes or modifications to the console not approved by Allen & Heath could void the compliance of the console and therefore the users authority to operate it.

WZ³14:4:2 User Guide AP5332 Issue 3

Copyright © 2005 Allen & Heath Limited. All rights reserved

ALLEN&HEATH Limited

Kernick Industrial Estate, Penryn, Cornwall, TR10 9LU, UK
<http://www.allen-heath.com>

Important Safety Instructions

WARNINGS - Read the following before proceeding :



ATTENTION: RISQUE DE CHOC ELECTRIQUE – NE PAS OUVRIR

- Read instructions:** Retain these safety and operating instructions for future reference. Adhere to all warnings printed here and on the console. Follow the operating instructions printed in this User Guide.
- Do not remove cover:** Operate the console with its covers correctly fitted. Disconnect mains power by unplugging the power cord if the cover needs to be removed for setting internal options. Refer this work to competent technical personnel only.
- Power sources:** Connect the console to a mains power unit only of the type described in this User Guide and marked on the rear panel. Use the power cord with sealed mains plug appropriate for your local mains supply as provided with the console. If the provided plug does not fit into your outlet consult your service agent for assistance.
- Power cord routing:** Route the power cord so that it is not likely to be walked on, stretched or pinched by items placed upon or against it.
- Grounding:** Do not defeat the grounding and polarisation means of the power cord plug. Do not remove or tamper with the ground connection in the power cord.



WARNING: This equipment must be earthed.

- Water and moisture:** To reduce the risk of fire or electric shock do not expose the console to rain or moisture or use it in damp or wet conditions. Do not place containers of liquids on it which might spill into any openings.
- Ventilation:** Do not obstruct the ventilation slots or position the console where the air flow required for ventilation is impeded. If the console is to be operated in a rack unit or flightcase ensure that it is constructed to allow adequate ventilation.
- Heat and vibration:** Do not locate the console in a place subject to excessive heat or direct sunlight as this could be a fire hazard. Locate the console away from any equipment which produces heat or causes excessive vibration.
- Servicing:** Switch off the equipment and unplug the power cord immediately if it is exposed to moisture, spilled liquid, objects fallen into the openings, the power cord or plug become damaged, during lightening storms, or if smoke, odour or noise is noticed. Refer servicing to qualified technical personnel only.
- Installation:** Install the console in accordance with the instructions printed in this User Guide. Do not connect the output of power amplifiers directly to the console. Use audio connectors and plugs only for their intended purpose.



Important Mains plug wiring instructions.

The console is supplied with a moulded mains plug fitted to the AC mains power lead. Follow the instructions below if the mains plug has to be replaced. The wires in the mains lead are coloured in accordance with the following code:

TERMINAL		WIRE COLOUR	
		European	USA/Canada
L	LIVE	BROWN	BLACK
N	NEUTRAL	BLUE	WHITE
E	EARTH GND	GREEN & YELLOW	GREEN

The wire which is coloured Green and Yellow must be connected to the terminal in the plug which is marked with the letter E or with the Earth symbol. **This appliance must be earthed.**

The wire which is coloured Blue must be connected to the terminal in the plug which is marked with the letter N.

The wire which is coloured Brown must be connected to the terminal in the plug which is marked with the letter L.

Ensure that these colour codes are followed carefully in the event of the plug being changed.

General Precautions

- Damage :** To prevent damage to the controls and cosmetics avoid placing heavy objects on the control surface, scratching the surface with sharp objects, or rough handling and vibration.
- Environment :** Protect from excessive dirt, dust, heat and vibration when operating and storing. Avoid tobacco ash, smoke, drinks spillage, and exposure to rain and moisture. If the console becomes wet, switch off and remove mains power immediately. Allow to dry out thoroughly before using again.
- Cleaning :** Avoid the use of chemicals, abrasives or solvents. The control panel is best cleaned with a soft brush and dry lint-free cloth. The faders, switches and potentiometers are lubricated for life. The use of electrical lubricants on these parts is not recommended. The fader and potentiometer knobs may be removed for cleaning with a warm soapy solution. Rinse and allow to dry fully before refitting them.
- Transporting :** The console may be transported as a free-standing unit or mounted in a rack or flightcase. Protect the controls from damage during transit. Use adequate packing if you need to ship the unit.
- Hearing :** To avoid damage to your hearing do not operate any sound system at excessively high volume. This also applies to any close-to-ear monitoring such as headphones. Continued exposure to high volume sound can cause frequency selective or wide range hearing loss.



Introduction

Welcome to the Allen & Heath **WZ³14:4:2**, one of the latest generation of the popular **MixWizard** series of compact audio mixing consoles. We have tried to keep this user guide brief and to the point. Please read it fully before starting. Included is information on installing, connecting and operating the console, panel drawings, system block diagram and technical specification. For further information on the basic principles of audio system engineering, please refer to one of the specialist publications and resources available from bookshops, audio equipment dealers and the Internet.

Whilst we believe the information in this guide to be reliable we do not assume responsibility for inaccuracies. We also reserve the right to make changes in the interest of further product development.

We are able to offer further product support through our world-wide network of approved dealers and service agents. You can also access our Web site on the Internet for information on our full product range, our company pedigree, assistance with your technical queries, our contact details or simply to chat about matters audio. To help us provide the most efficient service please keep a record of your console serial number, and date and place of purchase to be quoted in any communication regarding this product.

www.allen-heath.com

Contents

Warranty	2	Console Connectors.....	13
General Precautions.....	4	Mono Input Channel.....	15
Introduction to this Guide.....	5	Stereo Input Channel.....	17
Front Panel Layout	6	Group/Aux Masters.....	18
Introducing the MixWizard	7	Master Section.....	19
Installing the Console.....	8	Talkback, Generator and Matrix.....	20
Connecting Power.....	9	Specifications	21
Connecting a Backup Supply	9	System Block Diagram.....	23
Connection Pinouts and Cables	10	User Options.....	24
Audio Connections.....	11	Cue Sheet.....	27
Connector Panel Layouts.....	12		

The diagram illustrates a comprehensive control panel for a mixing console, organized into several functional sections:

- Top Section:** Includes a LAMP indicator, MIC IN, TALKBACK TRIM, and PHONES outputs.
- Channel Strips (10, 11-12, 13-14):** Each strip features:
 - Gain controls (GAIN) for ST1, ST2, ST3, and ST4.
 - HF (High Frequency) and HM (High Mid) frequency sliders.
 - LM (Low Mid) and LF (Low Frequency) frequency sliders.
 - EQ IN (Equalization In) buttons.
 - AUX 1-6 send knobs with POST and PRE routing options.
 - PAN (Pan) and BAL (Balance) controls.
 - MUTE and PFL (Post-Fader Listen) buttons.
 - PK1 (Peak) and SIG (Signal) meters.
 - Vertical level meters with 0, 5, 10, 20, 30, and 00 dB markings.
- MATRIX Section:** Contains:
 - GRP 1-4 (Group) knobs.
 - LEVEL knobs for each group.
 - MUTE buttons for each group.
 - AFL (After-Fader Listen) buttons.
 - MTX A and MTX B matrix buttons.
- Monitoring and Utility Section:**
 - OSC/NOISE TRIM and PINK NOISE 1kHz OSC controls.
 - TB SELECT (Talkback Select) and L-R (Left-Right) buttons.
 - GRP 1-4, AUX 1-2, AUX 3-4, and AUX 5-6 buttons.
 - PFL/AFL (Post-Fader Listen/After-Fader Listen) buttons.
 - MONITOR and PRESS TO TALK buttons.
 - A 30dB level meter with a PFL/AFL indicator.
- Bottom Section:**
 - GRP1-4 TO LR (Group 1-4 to Left/Right) buttons.
 - PAN controls for each group.
 - LR SUM MONO and FRONT-OF-HOUSE STAGE MONITOR buttons.
 - AFL/PFL LISTEN NEGGE (After-Fader Listen/Post-Fader Listen Negative) button.
 - MUTE buttons for each channel.
 - AFL buttons for each channel.
 - Vertical level meters for channels 1, 2, 3, 4, L, and R.

Introducing the MixWizard WZ³14:4:2

The Allen & Heath MixWizard series of consoles includes several models. This user guide describes the **WZ³14:4:2** 4 group model. The 2 bus **WZ³12:2** and **WZ³16:2**, and the stereo input **WZ20S** consoles are described in separate publications. For further information on the MixWizard series please refer to the Allen & Heath web site.



The MixWizard is a compact console designed for professional sound mixing. It is built to the same high standards as our top of the range consoles, with individual circuit cards, potentiometers nutted to the panel for absolute strength, steel chassis, and no compromise circuit design ensuring the finest sonic performance.

The console can be operated free standing or in a 19" rack or flightcase. It is supplied with protective side trims fitted. These can be removed for rack mounting. The rear connector pod can be easily rotated for rear facing or underside connectors when rack mounted.

With its 4 band semi-parametric EQ, 4 groups, 6 auxes and stereo main output the **WZ³14:4:2** is equally at home mixing live shows, recordings and corporate events. Tamperproof recessed switches configure the console for optimum FOH or stage monitor operation. This 'dual functionality', pioneered by Allen & Heath, gives the console its unique ability to properly function as Front-of-House or stage monitor, or handle both at the same time, ideal as a hard working work horse for hire stock, touring and installed sound.

The **WZ³14:4:2** has 10 mono mic/line inputs, 2 fully featured dual input stereo channels and a 2-track replay input, a total of 20 inputs to the mix. Of special note is the addition of a 2 x 6 way matrix providing a useful multi-purpose output for those special demands such as recording and broadcast feeds, delay fills, zone feeds and so on. A host of top end features are provided including oscillator and pink noise generator, individual talkback to all outputs, comprehensive engineer's metering and monitoring, a lamp socket, and a dual redundant backup power supply input.

The base of the console can be removed to access internal pluggable option jumpers. These configure user preference for the aux sends, direct outputs and talkback mic phantom power. The aux and matrix outputs are impedance balanced but may be electronically balanced if required by fitting an optional part. A kit is also available to fit the optional Sys-Link II input/output card which allows the console to be linked to other Allen & Heath consoles.

Other accessories available include the Allen & Heath MPS12 backup power supply and LEDlamp gooseneck lamp with built-in dimmer.

Installing the Console

Free Standing

The console is supplied ready for free standing operation with its side trims fitted and connector pod positioned for rear access. If you are converting from rack to free standing then make sure the pod is correctly rotated and secured, and the side trims fitted as shown below:

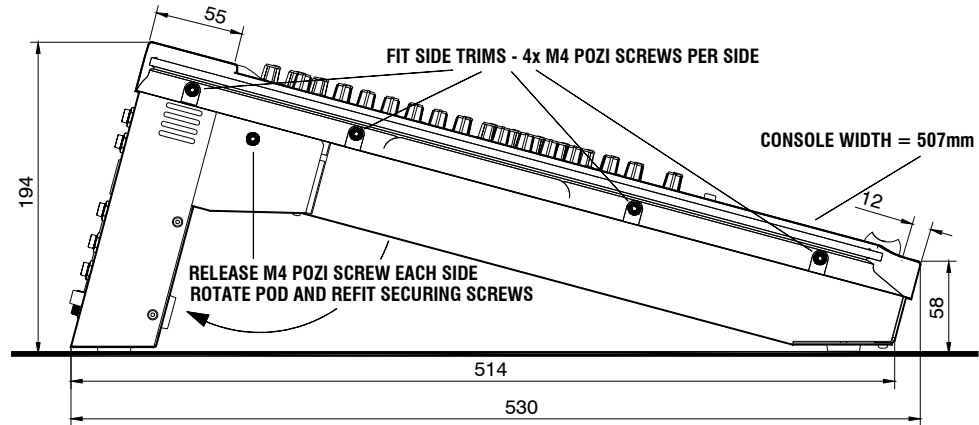

19" Rack Mount

For rack mounting, remove the two side trims and rotate the pod into the connector position preferred. Allow enough space for the cables and connectors behind the console.

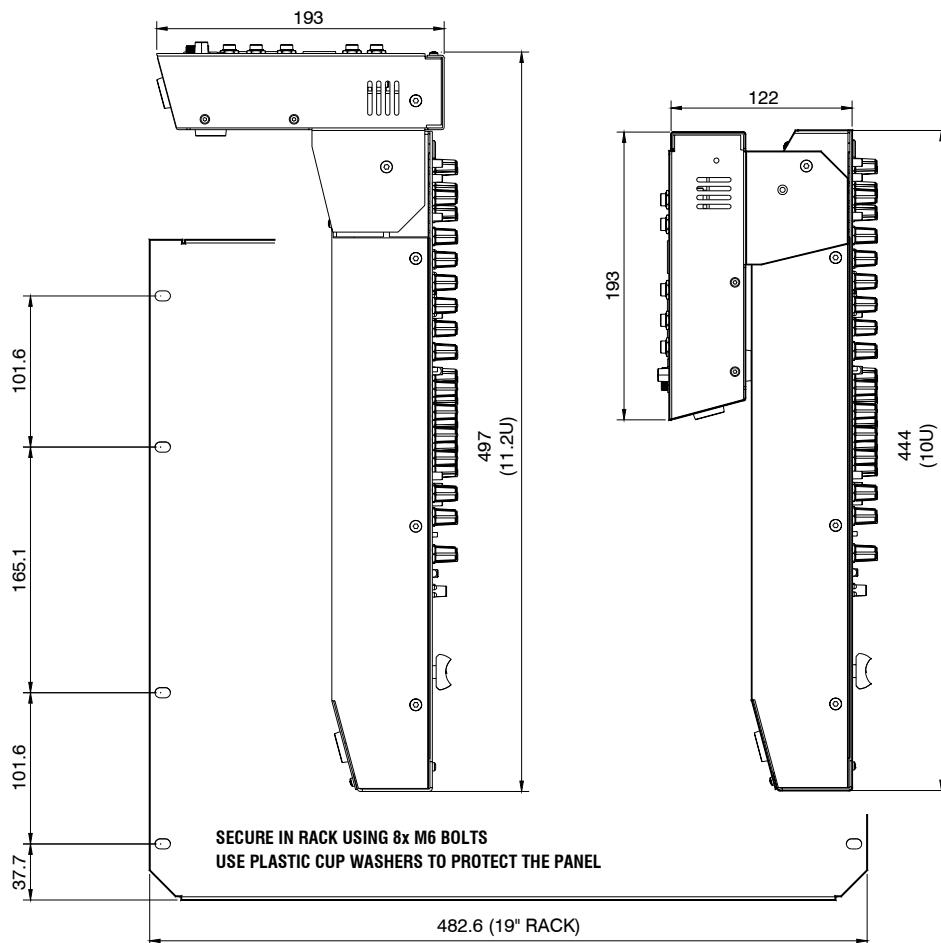

Do not transport the console with its connector pod securing screws removed. Do not attempt to remove the connector pod from the console. Do not obstruct the ventilation slots. Allow adequate space around the console for air flow. If the side-trims are to be removed, do not re-fit the (2x M4x10 and 6x M4x8) fixing screws to the unit. Please retain and store these screws in case the side-trims need to be re-fitted in the future.

Connecting Power



Read and understand the **Important Safety Instructions** printed at the start of this guide, and the warnings printed on the rear of the console. Check that your local mains supply is within the 100-240V operating voltage range allowed. Check that the correct mains lead with moulded plug has been supplied with your console. Make sure that the IEC mains plug is pressed fully into the panel socket before switching on.

Grounding

The connection to ground in an audio system is important for two reasons:



1. **SAFETY** - To protect the operator from high voltage electric shock, and
2. **AUDIO PERFORMANCE** - To minimise the effect of ground (earth) loops which result in audible hum and buzz, and to shield the audio signals from interference.

For safety it is important that all equipment grounds are connected to mains ground so that exposed metal parts are prevented from carrying high voltage which can injure or even kill the operator. Do not disconnect the ground connection in the mains lead. It is recommended that the system engineer check the continuity of the safety ground from all points in the system including microphone bodies, turntable chassis, equipment cases, rack metalwork and so on.

Switching the console on and off

It is good practice to turn power amplifiers off before switching the console and any other connected equipment on or off. This prevents any unexpected clicks or thumps when the equipment is powered up.



Turn amplifiers and powered speakers on last and off first.

To turn the console on, press the ON/OFF switch next to the IEC mains input socket. To turn the console off, press this switch again.

Connecting a backup supply

A socket is included for plugging in an optional backup power supply. This provides the reassurance of power supply dual redundancy, a feature usually found only in expensive top end consoles. The console uses diode combining technology so that both supplies can be powered at the same time. One will automatically take over should the other stop working. The recommended backup supply for the MixWizard is the Allen & Heath **MPS12** power unit. Refer to the user guide which comes with this supply.



Only plug the recommended Allen & Heath power unit into this socket. Do not attempt to modify any other power unit to work with the console. Do not attempt to modify or extend the DC power cable that comes with the supply.

The console can work with just the internal supply powered by mains, or just the backup supply, or with both powered at the same time. To ensure uninterrupted performance in the unlikely event of a failure, we recommended that both supplies are powered.

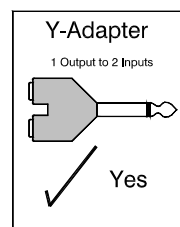
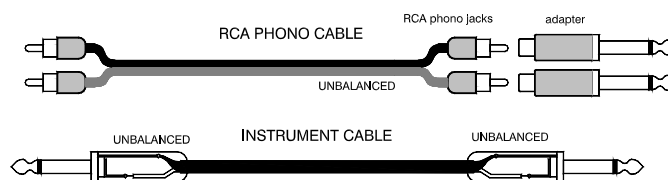
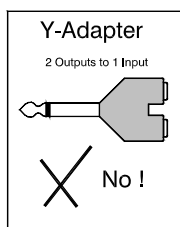
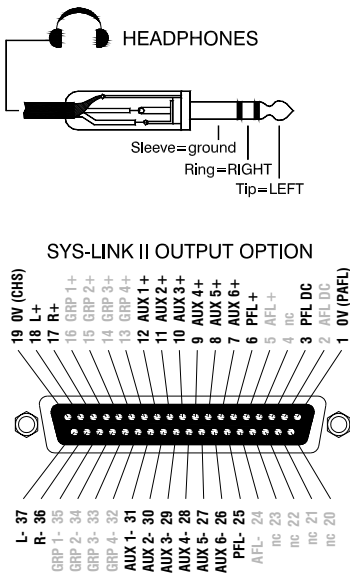
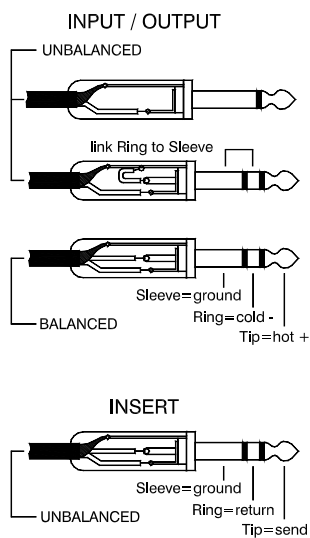
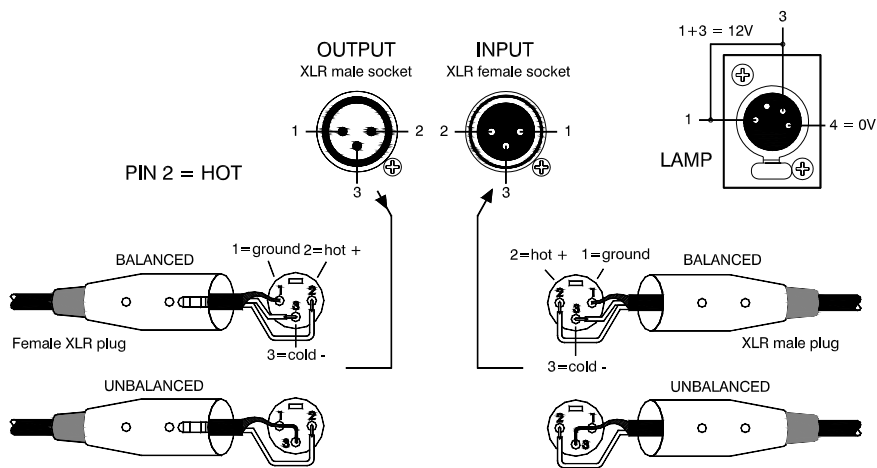

TO INPUT

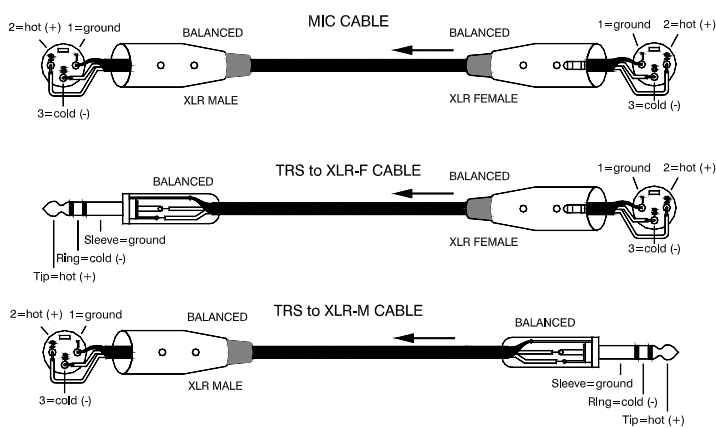

FROM OUTPUT

Audio Connections

The MixWizard uses professional grade 3 pin XLR, 1/4" TRS (3 pole) jack and RCA phono sockets. To ensure best performance, we recommend that you use high quality audio cables and connectors, and take time to check for reliable and accurate cable assembly. It is well known that most audio system problems are due to faulty or sub standard interconnecting leads. The following plugs may be used to connect audio to the console:

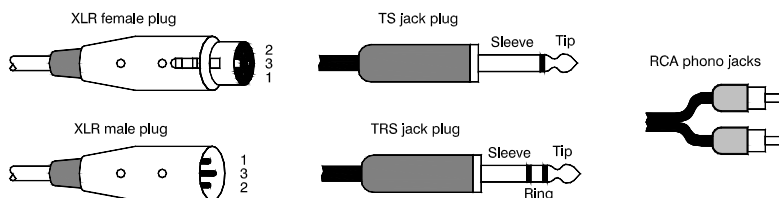

Avoid reversing + and - on balanced connections as this will result in reversed polarity (out of phase) signals which may cause signal cancellation effects.

Where long cables runs are required, balanced interconnections should be used. However, line level interconnections between more affordable 2-wire (signal, ground) unbalanced equipment and the console are unlikely to cause problems if the cables are kept shorter than 10 meters or so. Refer to the wiring diagrams on the opposite page.

Dealing with Ground Loops, Buzz and Interference

For optimum performance all audio signals should be referenced to a solid, noise-free ground (earth) point, frequently referred to as the 'star point' or 'clean earth'.

A ground loop is created when potential differences exist between grounds at different points in the system, and the signal has more than one path to ground. In most cases ground loops do not result in audible problems. Should you experience hum or buzz caused by a ground loop, check first that each piece of equipment has its own separate path to ground. If so, operate ground lift switches on connected equipment in accordance with the instruction manuals. Alternatively disconnect the cable screen at the destination end only. This breaks the offending loop while keeping the signal shielding down the length of cable.



WARNING For operator safety do not remove the ground (earth) connection in the power lead of the console or connected equipment.

To avoid interference pickup keep audio cables away from mains power units and cables, thyristor dimmer units, computer equipment and mobile phones. Where this cannot be avoided, cross the cables at right angles to minimise interference

A note about balanced connections



A differentially balanced connection has two signal wires, signal + (hot) and signal - (cold) and a shield. The signal source generates positive going polarity down the + wire and negative polarity down the - wire. The destination input stage accepts the + signal on its non-inverting (+) input pin, but it inverts the - signal, adding it to the + signal. The result is that the wanted signal is boosted. Now examine what happens when unwanted interference (hum and noise) is induced into the cable. The noise is induced equally and with the same polarity into both wires. At the destination input the - wire signal gets inverted and added to the + signal. Because the polarity is the same on both input wires the noise cancels itself out at this input. For this interference rejection to work it is important that the source, the cable and the destination input are all balanced. Balancing provides greatest advantage with low level signals such as those produced by microphones.

An impedance balanced output provides similar interference rejection, but without the signal drive on the - wire. It does not generate a negative polarity signal at its - output. Instead, the - wire has no signal but is held at the same impedance as the + wire. This means that both wires pick up the noise equally resulting in cancellation as described above.

ALLEN&HEATH

MixWizard WZ³ 14:4:2

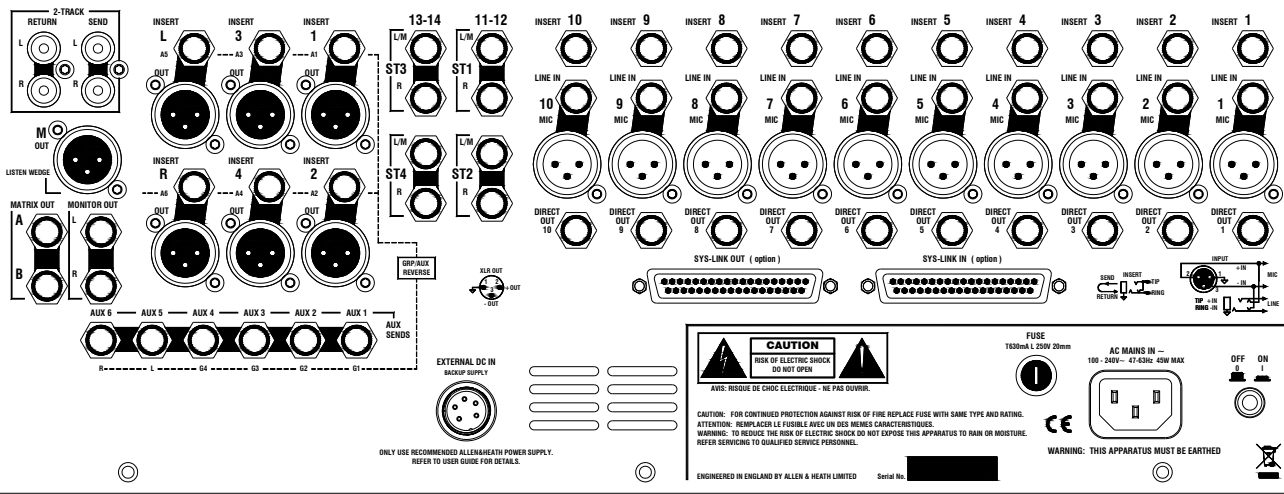

The Console Connectors

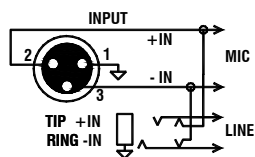

MIC / LINE IN The channel PAD (LINE) switch selects either the MIC XLR or the LINE TRS jack as the input source. The XLR is normalled through the TRS jack. This means that the XLR can be used for microphone or line level signals when nothing is plugged into the jack socket. Both inputs are balanced but can be wired to work with unbalanced signals when required.



WARNING: Do not connect unbalanced sources or cables to the XLR input when 48V phantom power is selected. To avoid loud clicks always turn the channel off by pressing MUTE when switching +48V on or off, and when plugging or unplugging cables.

STEREO LINE IN The WZ³14:4:2 has two stereo inputs for each of the two stereo channels. ST1 and ST2 feed channel 11-12, ST3 and ST4 feed channel 13-14. All inputs use TRS jacks. ST1 and 3 are unbalanced, ST2 and 4 are balanced. Unbalanced inputs automatically connect the TRS ring to ground for working with balanced sources. The L input is normalled through the R input to accept mono signals.

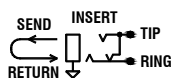

INSERT A single 3-pole TRS jack carries the unbalanced insert signal. Tip = send, Ring = return, Sleeve = common ground. The channel inserts are post-HPF, pre-EQ and operate at 0dBu. The group (aux) and LR mix inserts are pre-fader and operate at -2dBu. These should work fine with line level signal processing equipment such as compressors, outboard EQ, delay units and so on. An example of a suitable cable is shown here:

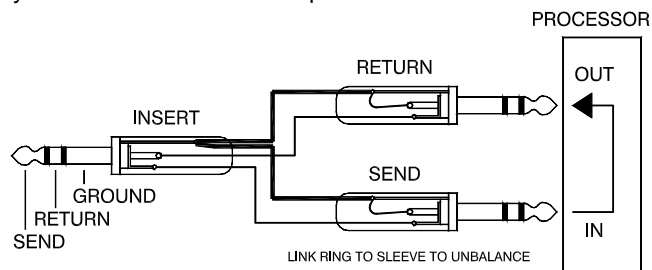

DIRECT OUTPUT The mic/line channel direct output is available on an impedance balanced TRS jack. It is a line level signal operating at 0dBu. The source is set using an internal option jumper for each channel. The factory default setting is pre-fade (following the pre/post-EQ setting). This may be changed to post-fade if preferred.

The direct outputs provide a useful source for multitrack recording. Many users prefer pre-fade sends for this application so that the live show fader movements do not affect the recording which can be mixed later. Another application is channel effects sends. For example, a reverb unit may be dedicated to work with the lead vocalist channel only. Using a post-fade direct output instead of an aux send frees up that aux mix for other purposes.

GROUP (Aux), L, R, M OUT The main console mix outputs are on balanced XLR. These produce +4dBu when the meters read '0'. The M output can be switched to provide a mono sum of the post-fade L and R signals, or the PFL/AFL engineer's wedge output.

The L and R outputs typically feed the house PA system in live sound mixing, or a 2-track recorder in studio mixing. In FOH mode, the M output can provide an additional feed for a mono fill speaker or zone, or be used as the main feed into a mono PA. In monitor mode the M output feeds the engineer's wedge monitor speaker with the AFL signal interrupted by PFL.

Group 1 – 4 outputs can be used to provide additional zone or special feeds, or for multitrack recording. In FOH mode they are often left unconnected where the groups are used as 'subgroups' for grouped level control and/or inserted processing. In monitor mode, the group and LR output XLRs and inserts become the aux mix masters. This configures the console with 6 main mix outputs capable of driving the stage monitors.

AUX OUT 1-6 Each aux send is available on an impedance balanced TRS jack operating at -2dBu line level. An internal option is available to fit a balanced line driver IC to provide an electronically balanced output operating at +4dBu. Note that it is not usual to require this option as the impedance balanced standard drive provides sufficient interference rejection when feeding balanced equipment inputs.

The aux sends are typically used to feed monitors, effects devices such as reverb and delay, and for special mix requirements. In monitor mode, these outputs reverse with the groups and LR connections.

MATRIX OUT A, B Each matrix output is available on an impedance balanced TRS jack operating at -2dBu line level. An internal option is available to fit a balanced line driver IC to provide an electronically balanced output operating at +4dBu. Note that it is not usual to require this option as the impedance balanced standard drive provides significant interference rejection when feeding balanced equipment inputs.

The matrix outputs are typically used for stereo or mono recording or broadcast feeds, delay and fill speakers, zone feeds, hearing assist loops and so on.

2-TRACK IN and OUT These connections are unbalanced on RCA phono sockets for connection to popular recording and playback devices such as CD, MiniDisc, computers and tape machines. Nominal line level is -2dBu. The 2-track SEND always follows the post-fade LR mix regardless of mode switch configuration. The 2-track RETURN can be used for monitoring a stereo recording, or as a simple stereo input for playback of walk-in and background music.

MONITOR OUT These impedance balanced line level TRS jack outputs follow the post-level monitor signal. Separate sockets are provided for the L and R signals. Use these to feed local speaker or other in-ear monitor systems.

SYS-LINK II OPTION A blank plate is fitted here as standard. The **WZ³14:4:2** Sys-Link II input/output option kit is available from Allen & Heath. Refer to OPTIONS later in this guide.

The MONO Input Channel

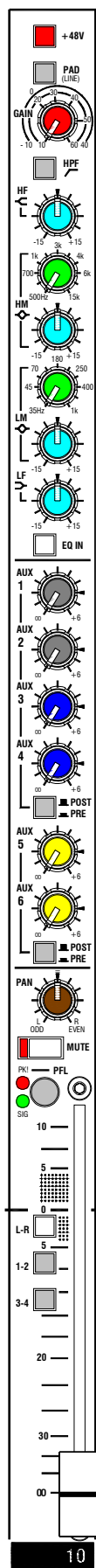

+48V Switches +48VDC to the channel input XLR for powering microphones or DI boxes that need phantom power. The power is current limited through 6k8 ohm resistors to pins 2 and 3.

WARNING: Do not connect unbalanced sources or cables to inputs with phantom power selected. To avoid loud clicks always mute the channel before switching +48V on or off and when plugging or unplugging microphones.

PAD (LINE) Press this switch to select the channel TRS jack LINE input. Release the switch to select the XLR MIC input. The XLR normals through the TRS socket. With nothing plugged into the line input the switch therefore becomes a PAD for the mic XLR. It attenuates the input signal by 20dB for connection to high level microphone or line sources.

GAIN Adjusts the input sensitivity to match the connected source to the internal 0dBu operating level of the channel. Provides a variable 50dB range from +10 to +60dB gain (mic), or -10 to +40dB (line, pad selected). The gain should be set using PFL so that the console meters average '0' with loudest moments lighting '+6'. Reduce gain if the red peak indicator lights.

Important note on setting channel levels: Use PFL to set the GAIN controls for correct signal level through each channel. Use the faders to balance each signal in the mix. We do not recommend setting the faders to '0' and mixing using the GAIN controls.

HPF Switches in the channel high pass filter. This attenuates frequencies below 80Hz by 12dB per octave. The filter is pre-insert, pre-EQ. Select the HPF to reduce low frequency noise such as microphone popping, stage noise and tape transport rumble.

EQ A 4-band semi parametric EQ provides independent control of four frequency bands. Use EQ IN to compare the sound with the equaliser switched in or out of circuit. HF and LF are shelving filters which affect high frequencies above 12kHz, and low frequencies below 80Hz respectively. HM and LM are bell shaped peak/dip filters which affect frequencies around a centre point which can be swept from 500Hz to 15kHz and 35Hz to 1kHz respectively. These have a width (Q) of 1.8. All bands can be boosted or cut by up to 15dB and have a centre detent 0dB position.

Check for the best microphone selection and placement before using the EQ. Start with the EQ set flat and apply only as much boost or cut as is really needed. When dealing with problem frequencies cut rather than boost where possible.

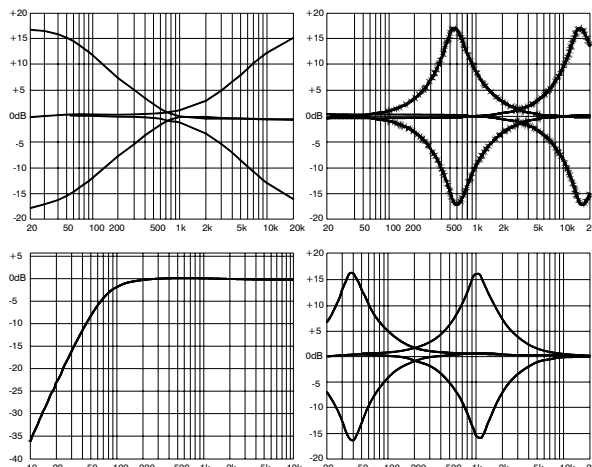

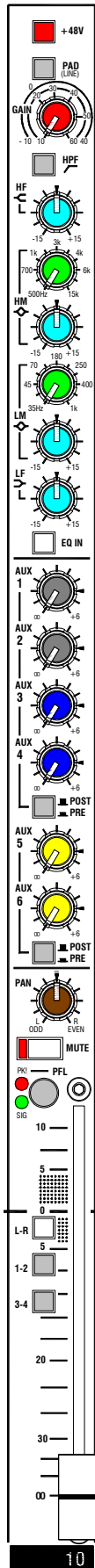

AUX SENDS These rotary controls adjust how much channel signal is mixed to the aux outputs. Each of the 6 auxes has its own control. They adjust from fully off to +6dB boost. Unity gain 0dB is marked at 3 o'clock position. Auxes 1-4, 5-6 are switched pre/post. These settings may be changed if preferred by repositioning internal jumper link options. They offer many different combinations of pre and post-fade sends, and a post-EQ option for the pre-fade sends. More detail is provided in OPTIONS later in this guide.

Pre-fade aux sends are not affected by the channel fader movements. These are typically used to feed stage monitors. In most cases users also prefer that the monitor sends are not affected by inserted processors or the channel EQ. Post-fade aux sends follow the channel faders and are typically used to send a proportion of the channel signal to an effects device such as reverb or delay. Note that post-fade sends may be preferred when the console is configured in monitor mode so that the faders become 'masters' for all monitor mixes. Pre or post-fade sends may also be used for special applications such as recording, zone feeds, clean feeds and aux fed subs.

PRE When pressed, the pre-fade channel signal is sent to the associated auxes. When released, the post-fade signal is sent. Auxes 1 to 4 and 5, 6 are grouped for pre/post switching. You can change this by repositioning the internal option jumpers.

PAN Positions the channel signal between L/R in the stereo mix, and odd/even if routed to the groups. The centre position (mono image) is detented for quick resetting.

MUTE When pressed, the channel signal is turned off. This affects the feed to the LR mix, pre and post-fade aux sends and direct output, but does not affect the insert send. The red indicator lights when the channel is muted.

PFL Press PFL to listen to the pre-fade channel signal in the headphones and local monitor without affecting the main outputs. The console main LR meters are interrupted with the channel signal. The red PK indicator half lights to show that PFL has been selected on that channel. Selecting more than one PFL at the same time mixes those signals together in the monitor.

PEAK The red indicator illuminates when the channel pre-fade signal is within 5dB of clipping. This gives you enough warning to reduce the GAIN control before you hear signal distortion.

SIGNAL The green signal presence indicator lights when the channel pre-fade signal is greater than -12dBu.

ROUTING Press L-R to route the channel signal to the main LR mix. Press 1-2 or 3-4 to route to the groups. Use PAN to position the signal between L/R or the odd/even group pairs. To route to a single group set PAN fully to one side. You can route to L-R and all groups simultaneously by pressing all switches. Check that you have set these switches correctly before you start mixing.

FADER Controls the channel level feeding the main LR mix, groups and post-fade aux sends. It also affects the direct output if this has been set to post-fade using the internal option jumpers. The fader provides +10dB maximum boost above its normal unity gain 0dB position.

The STEREO Input Channel

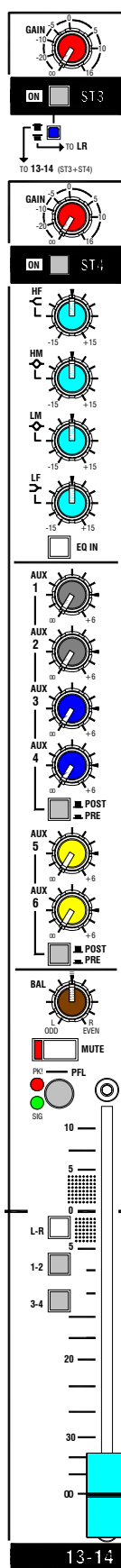

Dual stereo inputs Each of the two stereo channels has two stereo inputs which can be used separately, mixed together or split so that one feeds the channel, the other routes direct to LR. For example, you could mix two sound effects playback devices or two reverb returns together into one channel. This can be useful in saving channels, letting you mix many inputs in a small space. The L input signal normals through the R input socket so that a mono source may be plugged in to feed both left and right sides of the stereo channel.

ST1, ST3 Unbalanced TRS inputs. The GAIN control adjusts from fully off to +16dB gain. Press the ST1(3) switch to turn the input on.

Routing mode switch Recessed switch to prevent accidental operation. In the normal up position the ST1 (ST3) signal mixes with ST2 (ST4) into the stereo channel. When pressed the signal is routed direct to the LR mix instead of the channel. This lets you use these inputs as simple stereo returns in addition to the full stereo channels, providing four independent stereo sources to the LR mix.

ST2, ST4 Balanced TRS inputs. The GAIN control adjusts from fully off to +16dB gain. Press the ST2 (4) switch to turn the input on. These inputs always feed the stereo channels.

EQ A 4-band fixed frequency EQ provides independent control of four frequency bands. HF and LF are shelving filters which affect high frequencies above 12kHz, and low frequencies below 80Hz respectively. Use EQ IN to compare the sound with the equaliser switched in or out of circuit. HM and LM are bell shaped peak/dip filters which affect frequencies centred around 2.5kHz and 250Hz respectively. These have a width (Q) of 1.8. All bands can be boosted or cut by up to 15dB and have a centre detented 0dB position.

AUX SENDS These work as described for the mono channel. The L and R sides of the stereo signal sum together to feed each aux in mono. This can be changed using an internal jumper so that L feeds auxes 1, 3 and R feeds auxes 2, 4. The auxes are always post-EQ.

BAL Balances the level of the L signal against the R signal to compensate for differences in the source signal, or to position the signal within the stereo image. The centre equal level position is detented for quick resetting.

MUTE When pressed the channel signal is turned off. This affects the feed to the LR mix, groups and pre and post-fade aux sends. The red indicator lights when the channel is muted.

PFL Press PFL to display the summed L+R pre-fade channel signal on the main meters and listen to it in the headphones and local monitor without affecting the main outputs. The red PK indicator half lights to show that PFL has been selected on that channel.

PEAK The red indicator illuminates when the channel pre-fade signal is within 5dB of clipping. This gives you enough warning to reduce the GAIN control before you hear signal distortion.

ROUTING As the mono channel, routes the left signal to L and odd groups, right signal to R and even groups.

SIGNAL The green signal presence indicator lights when the channel pre-fade signal is greater than -12dBu.

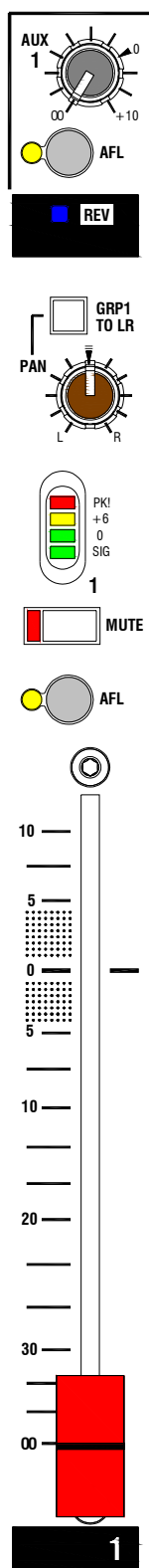

AUX MASTERS Each aux mix has a master level control that adjusts the output level to match external equipment, or trims the monitor, effect or other send without affecting the mix balance. Up to +10dB boost is available above the normal 0dB position.

AUX AFL Press AFL to listen to the post-level aux mix in the headphones and local monitor without affecting the main outputs. Note that this becomes the group mix in monitor mode. The console main meters are interrupted with the aux (group) signal. The yellow indicator lights to show that AFL has been selected on the master. Use AFL to check the signal being sent to the monitors, effects or other destination.

REV These switches reverse the function of the group and aux masters. They are recessed to prevent accidental operation. Use a pen or pointed object to set their position. In the up position (flush with the panel), the group is controlled by the fader and the aux by the rotary master. This is typical for FOH mode where the faders are used for subgroups feeding the main stereo mix. When pressed, the aux uses the fader as the master and the group is moved to the rotary control. The aux mix is now presented to rear Group XLR complete with insert. The group mix appears at the Aux TRS jack. This is used for monitor mode where the auxes are the main mix feeding the stage monitors. You can select any combination for the FOH and monitor mode, for example, just 3, 4 giving you two fader subgroups, two monitor sends on faders, and main LR mix.

Note: The groups always feed the matrix and the subgroup controls (PAN and GRP TO LR) regardless of mode. This means the group mix can still perform a useful function when the console is configured in monitor mode.

PAN Positions the group signal between L and R in the stereo mix when the GRP TO LR switch is pressed. Using pan you can create mono or stereo groups positioned as you require in the main mix. For stereo grouping, set the odd group pan fully to the left, and the even group pan fully to the right. The centre position (mono image) is detented for quick resetting. Note that the group mix always feeds these subgroup controls regardless of FOH or monitor mode selected.

METER A 4 LED bar meter displays the post-fade group signal (FOH mode), or aux signal (monitor mode, REV pressed).

MUTE When pressed the group (aux) signal is turned off. This affects the feed to the output XLR, LR and matrix. The red indicator lights when the channel is muted.

GROUP AFL Press AFL to listen to the post-fade group mix in the headphones and local monitor without affecting the main outputs. Note that this becomes the aux mix in monitor mode. The console main meters are interrupted with the group (aux) signal. The yellow indicator lights to show that AFL has been selected on that master.

GROUP FADER Controls the group mix output level. Note that it becomes the aux mix master in monitor mode (REV pressed). The fader provides +10dB maximum boost above its normal unity gain 0dB position.

TALKBACK, SIGNAL GENERATOR and MATRIX

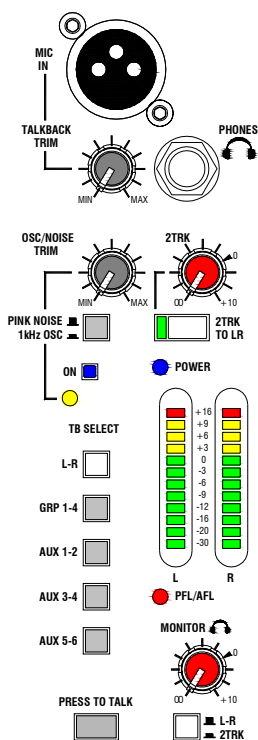

TALKBACK Individually assignable talkback is available to all the main outputs. Plug in a suitable cable or gooseneck microphone. A good quality dynamic or condenser vocal microphone is recommended. Note that +48V phantom power is available at the XLR as standard. If you prefer, this can be disabled by repositioning an internal jumper link.

WARNING: Do not connect unbalanced sources or cables to inputs with phantom power selected. To avoid loud clicks do not press the TALK switch when plugging or unplugging the talkback microphone.

First select the source you wish to talk to. You can select the auxes in pairs, useful for communicating with the performers on stage. The four groups are selected simultaneously, ideal for identifying a multitrack recording. You can also talk to LR, ideal for announcements to the audience. Once selected, press TALK to route the mic to the required destination. Adjust the talkback level using the TRIM control below the TB mic XLR.

SIGNAL GENERATOR / PINK NOISE Press to select either pink noise (up position) or a 1kHz sine wave tone as the test source. Start with the trim control turned fully down. The generator ON switch is recessed to prevent accidental operation. Press this with a pen or pointed object. The green indicator lights to warn that the generator is enabled.

The generator signal is routed to any source selected on the switch bank above the TALK switch. Use the signal to test the loudspeaker system and line up connected equipment. Pink noise is useful for quickly testing the full range frequency operation and phasing/polarity of loudspeakers. The 1kHz tone is better suited to lining up equipment with its steady reading on the meters.

WARNING: We recommend you turn off the signal generator once you have finished using it to test and line up your system. This will prevent accidental operation during the show.

MATRIX The matrix provides 2 additional console outputs. It is a 'mixer within a mixer' taking its source from the groups and main mix. It can be used to provide duplicate main outputs or to create new mixes from the main outputs. The controls are positioned conveniently away from the live performance controls to avoid accidental operation.

Each of the 4 groups, L and R can be mixed independently into the matrix. The source is derived post-fader. Adjust the level clockwise from fully off to +6dB boost. Use the LEVEL control to adjust the matrix output level from fully off to a maximum boost of +6dB. The '0dB' positions are marked. The matrix output can be muted. The post-level signal can be monitored using the AFL switch.

Use the matrix to create special mixes such as delay, fill and zone speakers, recording and broadcast feeds, hearing assist loop and so on.

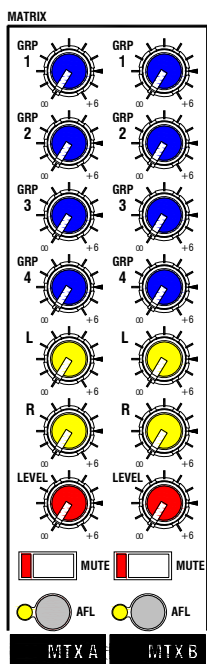

Specifications

Performance

Maximum output level	XLR	+26dBu into 600 ohms max load
	Jack	+21dBu into 2k ohm max load
Internal headroom	Channels	+21dB
	Mix	+23dB
Meters	3 colour LED, quasi peak response	
Sensitivity	0VU = +4dBu at XLR output	
Master meters	12 segment	-30 to +16dB
Channel meters	2 segment	-12, +16dB (5dB before clip)
Frequency response	20Hz to 50kHz	+/-0.5dB
THD+n at +10dBu 1kHz	Channel to mix out < 0.004%	
Crosstalk at 1kHz	Fader shutoff	>90dB
	Mute shutoff	>100dB
	Inter channel	>90dB
Noise, rms 22Hz to 22kHz	Mic EIN	-128dB
	Residual output noise	< -96dBu (-100dB S/N)
	LR unity fader mix noise	< -84dBu (-88dB S/N)
	Group unity fader noise	< -90dBu (-94dB S/N)
Channel HPF	12dB/octave below 80Hz	
Mono EQ	HF	Shelving, +/-15dB, 12kHz
	HM	Peak/dip, +/-15dB, 500Hz to 15kHz, Q=1.8
	LM	Peak/dip, +/-15dB, 35Hz to 1kHz, Q=1.8
	LF	Shelving, +/-15dB, 80Hz
Stereo EQ	HF	Shelving, +/-15dB, 12kHz
	HM	Peak/dip, +/-15dB, 2.5kHz, Q=1.8
	LM	Peak/dip, +/-15dB, 250Hz, Q=1.8
	LF	Shelving, +/-15dB, 80Hz
Power supply	Internal	100-240V, 50/60Hz auto sensing, IEC input
	External Input	Input for optional MPS12 backup supply
	Power consumption	35W max
	Mains fuse	T630mA L 20mm

Mechanical

Free standing dimensions	W 507 (20") x D 530 (20.9") x H 194 (7.7")	
Rack mounted Underside connectors	W 483 (19") x D 122 (4.8") x H 444 (17.5") 10U	
Rack mounted Rear connectors	W 483 (19") x D 193 (7.6") x H 497 (19.6") 11.2U	
Weight	10kg (22lbs)	

Connections

Mono channel	XLR balanced pin 2 hot	Sensitivity -60 to +10dBu
	TRS balanced, tip hot	Sensitivity -40 to +10dBu
	Pad out (MIC)	2k ohm
	Pad in (MIC or LINE)	>10k ohm, -20dB
	Max input level	+30dBu
	XLR phantom power	+48V, on/off
Stereo channel	ST1,3 TRS unbalanced	>10k ohm, -16 to +20dBu
	ST2,4 TRS balanced	>10k ohm, -16 to +20dBu
Talkback mic	XLR balanced pin 2 hot	Sensitivity -50 to -10dBu
	Phantom power	Internal jumper +48V
2-track return	RCA phono, unbalanced	>4k ohm, -8 to +4dBu
2-track send	RCA phono, unbalanced	< 1k ohm, -2dBu
Inserts	Channel	TRS, tip send, ring return, 0dBu
	Output	TRS, tip send, ring return, -2dBu
L, R, M outputs	XLR balanced pin 2 hot	<75 ohm, +4dBu, +26dBu max
Group (aux) out	XLR balanced pin 2 hot	<75 ohm, +4dBu, +26dBu max
Aux 1-6 output	TRS impedance balanced	<75 ohm, -2dBu, +21dBu max
	Electronic balance option	<75 ohm, +4dBu, +26dBu max
Direct out	TRS impedance balanced	<75 ohm, 0dBu, +21dBu max
Matrix out	TRS impedance balanced	<75 ohm, -2dBu, +21dBu max
	Electronic balance option	<75 ohm, +4dBu, +26dBu max
Headphones	TRS, tip L, ring R, 30 to 600 ohm headphones recommended	
Monitor output	TRS impedance balanced	<75 ohm, -2dBu, +21dBu max
Lamp	4-pin XLR	max 12V 5W lamp

MixWizard 3 Series Part Numbers

WZ ³ 12:2	8 mic/line, 2 dual stereo, LR console	W31202/v
WZ ³ 16:2	16 mic/line LR console	W31602/v
WZ ³ 14:4:2	10 mic/line, 2 dual stereo, 4 group console	W31442/v
WZ ³ 12:2 and WZ ³ 16:2	Sys-Link II output option kit	W312/16-SLV2
WZ ³ 14:4:2	Sys-Link II input/output option kit	W31442-SLV2
SSM2142P	balanced output driver option IC	AE0302
DRV134	balanced output driver option IC (alternative to above)	AE5725
Allen & Heath	MPS12 backup power supply option	MPS12/v
Allen & Heath	18" gooseneck LED lamp	LEDLAMP

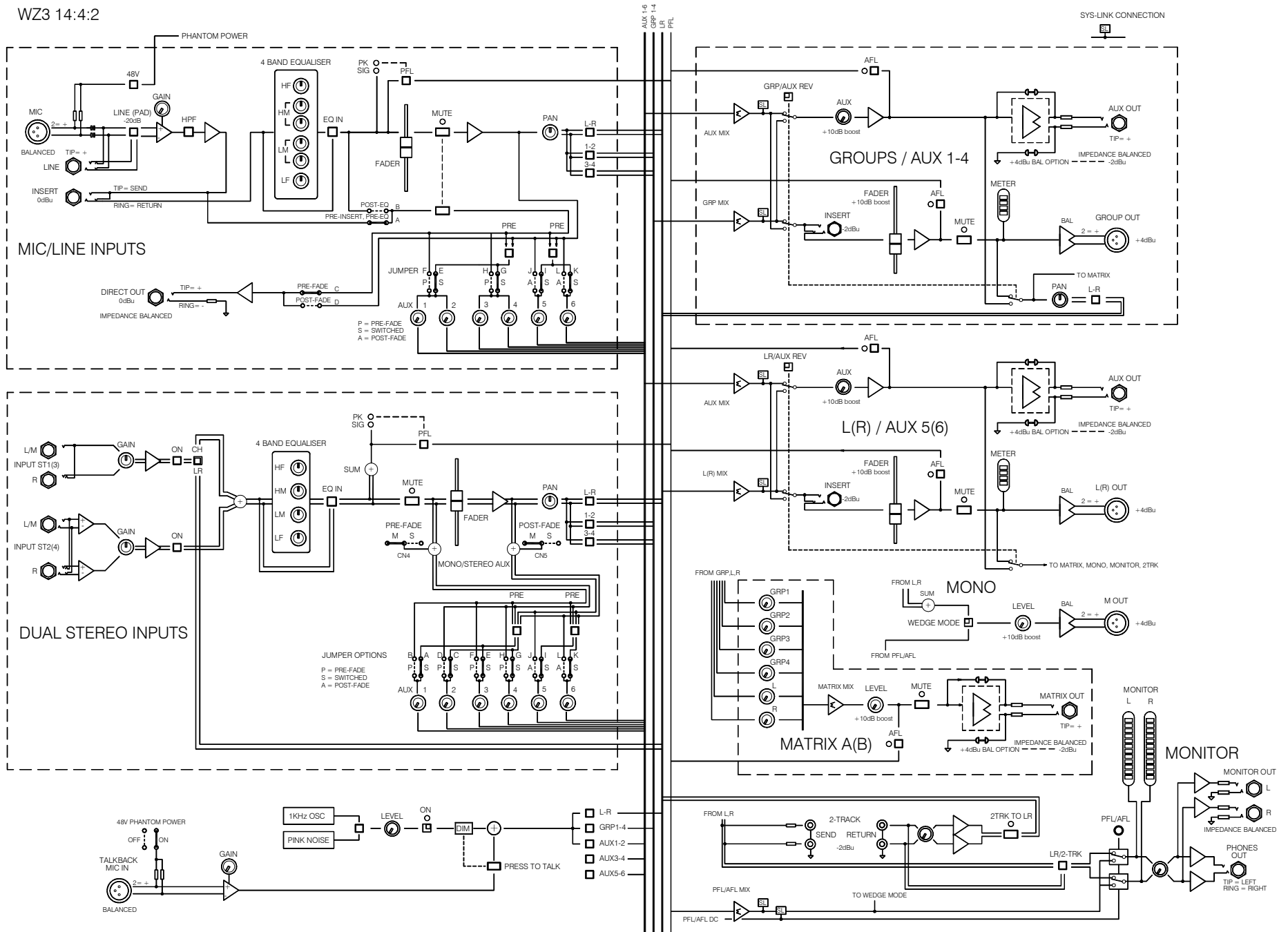

User Options

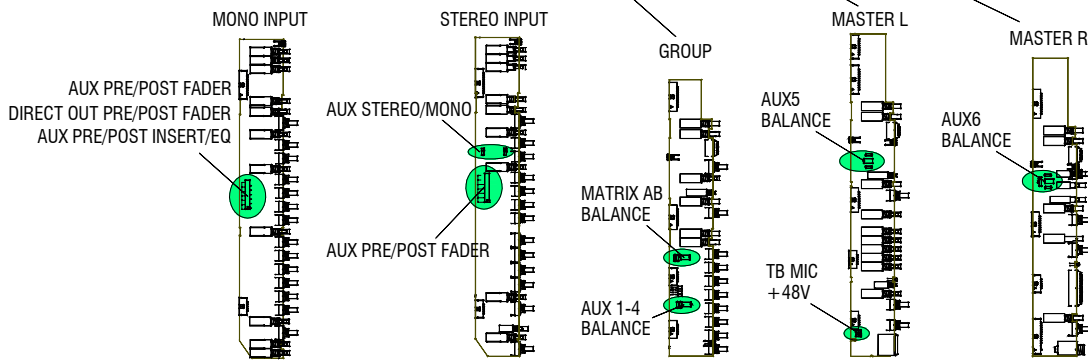
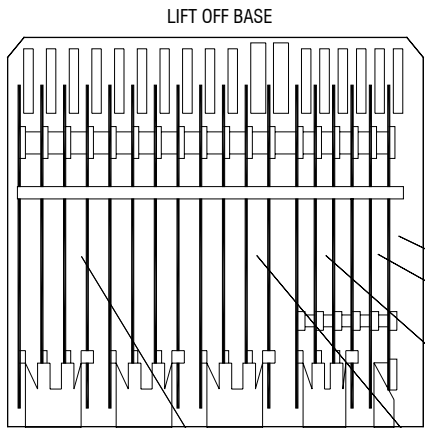
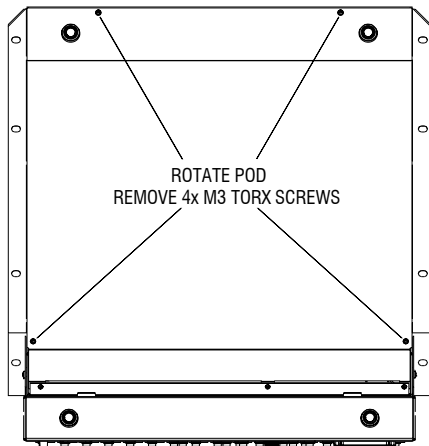
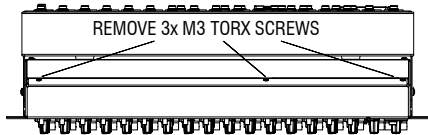
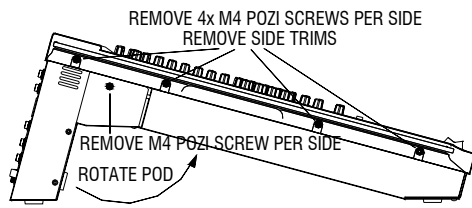

The MixWizard has a versatile architecture which should satisfy most applications you may encounter without modification. However, the following internal options provide alternative settings for those applications that may demand them. Access is required to the internal assemblies. For user convenience, pluggable jumper links are used in most places.

Remove the base Start by removing the side trims if fitted using a Pozi crosshead screwdriver. Release the two M4 Pozi head pod securing screws and rotate the connector pod to gain access to the three M3 rear base fixing screws. Use a Torx starhead screwdriver to remove these. Rotate the pod again to remove the four M3 underside base screws using the Torx driver. Carefully lift off the base.

Configure the internal options Fit the options required. Set the option jumpers to the required positions. Make sure they are pressed fully home. Check that all channels are correctly set and all options fitted according to their instructions. Make sure that no debris or parts are left loose inside the console.

Refit the base Carefully reposition the base. Refit the fixing screws. Lock the connector pod in the required position using the securing screws. Refit the side trims if required.

IMPORTANT: Check carefully that all channel jumpers are correctly set as required. Errors on one or more channels now may cause user problems later. We recommend that you write the repositioned jumper settings on a label and adhere this to the rear panel. This would provide a helpful reference to other users of the console.

MONO CH - AUX PRE/POST EQ

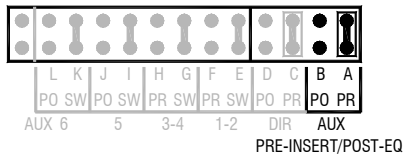

MONO CH - DIRECT OUT

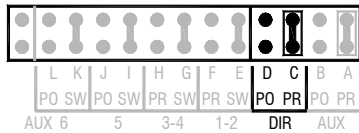

MONO CH - AUX PRE/POST FADER

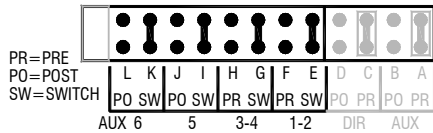

STEREO CH - AUX PRE/POST FADER

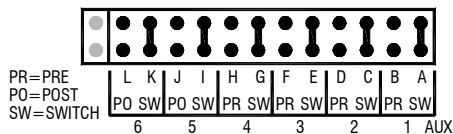

STEREO CH - MONO/STEREO AUXES

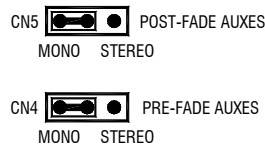

L MASTER - TALKBACK +48V



Aux pre/post insert / EQ Factory default for the mono channel pre-fade auxes is pre-insert, pre-EQ. This is popular with many users mixing monitors from FOH. It prevents the channel EQ and inserted compressors affecting the monitor mix. Move the jumper from A to B to change this to post-insert, post-EQ if preferred. Note that auxes are always post-mute.

Direct output source Factory default is pre-fader. This is common for live recording to multitrack. The live mix fader movements do not affect the recording. Move the jumper from C to D to change to post-fade. Post-fade is appropriate when using the output as a direct channel effects send.

Channel Aux pre/post settings Factory default is Aux 1-4 = switched, Aux 5-6 = switched. You can change these settings for different combinations of pre/post or switched auxes by repositioning the links. Refer to the system block diagram to explore the possibilities. Make sure you set all mono and stereo channels the same. We recommend you only change these settings if absolutely necessary.

Stereo/Mono aux source The stereo channels can feed the auxes with a mono sum of L+R, or be configured so that L feeds the odd numbered auxes, and R the even. This is preferred when using odd/even auxes as stereo pairs. Factory default is the mono setting.

Talkback mic +48V The factory default is +48V phantom power turned on for the front panel talkback mic XLR input. The option jumper is behind the TB mic XLR on the L Master board. If you prefer, phantom power can be disabled by repositioning the jumper to the GND position.

Note that phantom power should not harm non-powered dynamic microphones as long as balanced connections are used.

WARNING: Do not connect unbalanced sources or cables to inputs with phantom power selected. To avoid loud clicks do not press the TALK switch when plugging or unplugging the talkback microphone.

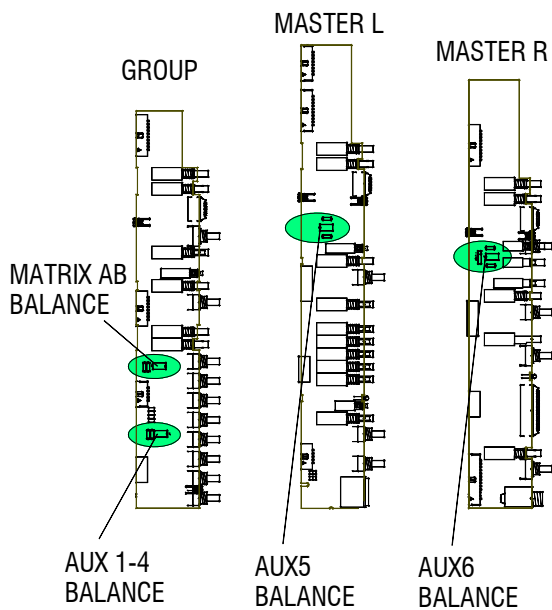

Output balance options The aux and matrix outputs are impedance balanced as standard operating at nominal -2dBu and with +21dBu maximum drive. They provide similar interference rejection to electronically balanced outputs when connected to balanced equipment inputs. An electronically balanced option is available if you require nominal +4dBu and higher output drive up to +26dBu over very long cable runs. However, it is not usually necessary to fit this option as the impedance balanced drive satisfies most applications. Check that you really need the option before fitting it.

There are two balanced driver ICs which may be used. Either is suitable. These are available from Allen & Heath or most electronic component suppliers. The Allen & Heath part number is shown below:

SSM2142P	A&H Part AE0302
DRV134	A&H Part AE5725

For each aux master, snip the legs of the two zero ohm resistor links next to the IC socket. This removes them from the circuit. Now simply plug the option IC into the socket. Observe the correct IC pin1 orientation and make sure its legs are correctly aligned with the socket. Test the output once the work is complete. You should measure the same level but opposite polarity signal between + (hot) and ground, and – (cold) and ground.

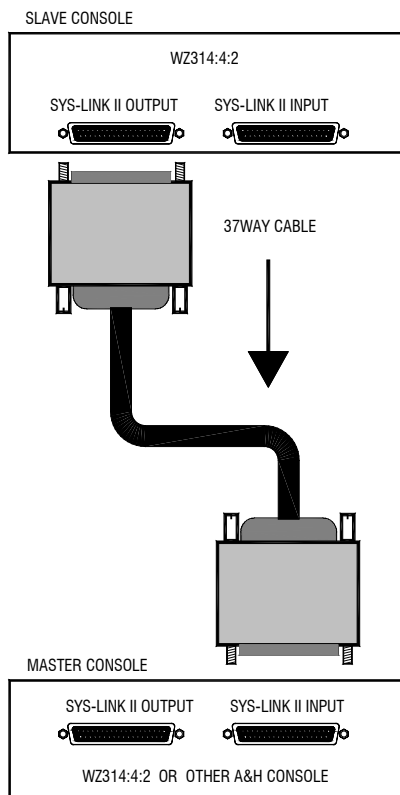

Sys-Link II input/output option A blank plate is fitted here as standard. This may be replaced with an optional card which provides the console inputs, outputs and PFL system on two 37way D connectors for linking to other Allen & Heath consoles already fitted with Sys-Link II. The **WZ³14:4:2** can become an input channel expander (slave) or have its number of input channels expanded (master) when linked to other consoles.

A 37way shielded multi-core cable carries the MixWizard balanced mix signals and PFL system to or from the other console.

IMPORTANT: Note that you need an adapter cable if you are connecting Sys-Link II (Version 2) to the older Sys-Link I (Version 1) standard.

For full details please refer to the Sys-Link option Applications Note AP5738 and Fitting Instructions AP5737.

Cue Sheet

WZ³14:4:2

Copy and use this page to record your console settings.

ALLEN&HEATH MixWizard WZ³14:4:2

The cue sheet is a grid of controls for recording console settings. It includes sections for:

- Channels 1-10, 11-12, 13-14:** Each channel has a vertical stack of controls: +48V, PAD, GAIN, HFE, HF, 700Hz, 3000Hz, LM, LF, EQ IN, AUX 1-6, PAN, BAL, PFL, SIG, and DIS.
- GROUPS (GRP 1-4):** Controls for each group, including GAIN, HFE, HF, LM, LF, EQ IN, and MUTE.
- AUXILIARIES (AUX 1-6):** Controls for each auxiliary, including PFL, SIG, DIS, and MUTE.
- MATRIX:** Controls for each matrix channel, including PFL, SIG, DIS, and MUTE.
- OSCILLATOR NOISE (OSC NOISE TRIM, PINK NOISE, 1MHz OSC):** Controls for noise generation.
- POWER:** Controls for power settings, including ON, TB SELECT, GRP 1-4, AUX 1-2, AUX 3-4, AUX 5-6, MUTE, and PRESS TO TALK.
- FRONT OF HOUSE (FOH) and STAGE MONITOR (SM):** Controls for monitoring, including PFL, SIG, DIS, and MUTE.