

FiberSource QFX 150

user manual

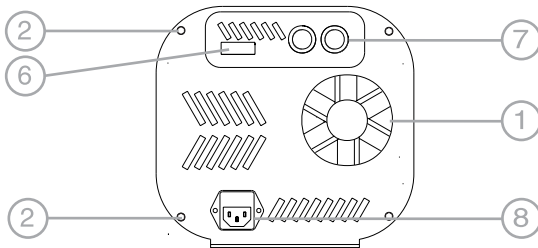

- 1 cooling fan
- 2 lamp access cover screw
- 3 adaptor set screw
- 4 cable socket
- 5 mounting flange
- 6 DIP-switch
- 7 data sockets
- 8 AC input & main fuse

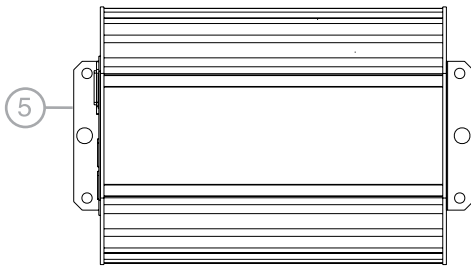
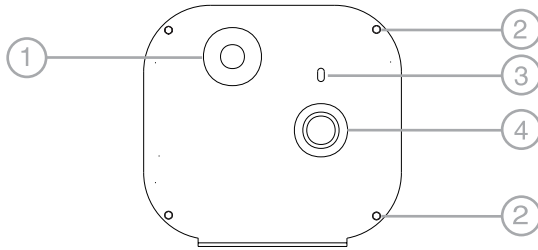

©1999-2006 Martin Professional A/S, Denmark.

All rights reserved. No part of this manual may be reproduced, in any form or by any means, without permission in writing from Martin Professional A/S, Denmark.

Printed in Denmark.

P/N 35000079, Rev. D

INTRODUCTION	4
LAMP	6
AC POWER	7
INSTALLATION	9
FIBER OPTIC CABLE	11
CONTROLLER OPERATION	12
STAND-ALONE OPERATION	16
MASTER/SLAVE OPERATION	18
BASIC SERVICE	19
TROUBLESHOOTING	22
DMX PROTOCOL	23
SPECIFICATIONS	25
ACCESSORIES	26

INTRODUCTION

1

Thank you for selecting the Martin FiberSource QFX 150. This fiber optic lighting fixture uses a long-life 150 watt discharge lamp and provides 4 colors plus white, full-range dimming, and a variable-speed twinkle effect. It operates with DMX-512 controllers, in stand-alone mode, and in master/slave configuration.

SAFETY INFORMATION

Warning! *This product is for professional use only. It is not for household use.*

This product presents risks of lethal or severe injury due. **Read this manual** before powering or installing the fixture, follow the safety precautions listed below and observe all warnings in this manual and on the fixture. If you have questions about how to operate the fixture safely, please contact your Martin dealer or call the Martin 24-hour service hotline.

To protect yourself and others from electric shock

- Disconnect the fixture from power before removing or installing the lamp, fuses, or any part, and when not in use.
- Always ground (earth) the fixture electrically.
- Use only a source of power that complies with local building and electrical codes and has both overload and ground-fault protection.
- Do not expose the fixture to rain or moisture.
- Refer all service to a qualified technician.

To protect yourself and others from UV radiation and lamp explosion

- Do not operate the fixture without a fiber optic cable inserted.
- When replacing the lamp, allow the fixture to cool for at least 5 minutes before opening. Protect your hands and eyes with gloves and safety glasses.
- Never look at a lamp while it is lit.
- Replace the lamp when it becomes defective or worn out, or before usage exceeds 110 percent of the rated average life.

To protect yourself and others from burns and fire

- Never attempt to bypass the thermostatic switch or fuses. Always replace defective fuses with ones of the specified type and rating.
- Keep all combustible materials (for example fabric, wood, paper) at least 0.1 meters (4 inches) away from the fixture. Keep flammable materials well away from the fixture.
- Provide a minimum clearance of 0.1 meters (4 inches) around fans and air vents.
- Allow the fixture to cool before handling.
- Do not modify the fixture or install other than genuine Martin parts.
- Do not operate the fixture if the ambient temperature (T_a) exceeds 40°C (104°F).

To protect yourself and others from injury due to falls

- When suspending the fixture above ground level, verify that the structure can safely hold the weight of all installed devices.
- Verify that all external covers and rigging hardware are securely fastened and use an approved means of secondary attachment such as a safety cable.
- Block access below the work area whenever installing or removing the fixture.

UNPACKING

The packing material is carefully designed to protect the fixture during shipment - always use it to transport the fixture.

The FiberSource QFX 150 comes with:

- Osram HQI-R 150 W lamp
- 3 m power cable w/ 3-pin IEC female cord cap
- 4 dichroic color filters
- user manual

LAMP

2

The FiberSource QFX 150 is designed for use with the Osram HQI-R 150 lamp. Do not install any other type of lamp.

Warning! *Disconnect the fixture from power and allow it to cool before opening.*

Important! *Turn the lamp so that the arc is horizontal.*

To install or position the lamp

- 1 Remove the 4 lamp access cover screws and pull off the access cover, which is indicated by the arrow on the rear panel.
- 2 To remove the lamp, place a hand under it and pull it out. Do not lift by the ceramic base alone. Squeeze the sides of the lamp plug and pull it out.
- 3 To position the lamp, turn it so the wires, where they exit the lamp base, point towards the ground when the fixture is installed. This puts the arc in its ideal burning position.
- 4 To install a lamp, plug in the connector and then place the reflector rim in the slot. Gently press the lamp between the springs until it snaps into place.
- 5 Remove and turn the diffusion filter 90°, if necessary, so the long sides of the prisms align with the arc.
- 6 Check the power setting as described in the next section before replacing the lamp access cover.

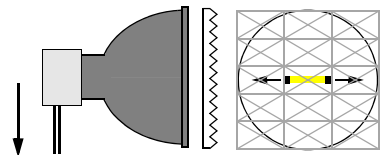
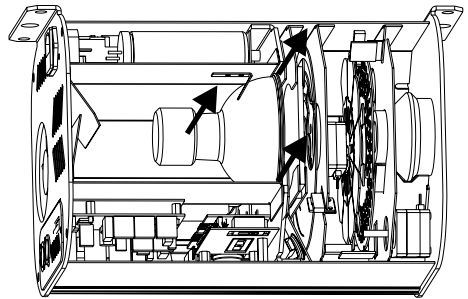

Turn lamp so wires point towards ground and arc is horizontal.

Align long edge of diffuser prisms with arc.

AC POWER

The FiberSource QFX 150 has 10 switch-selectable power supply settings. Always use the setting that is closest to the local AC supply.

Warning! *For protection from electric shock, the fixture must be grounded (earthed). The power supply shall have overload and ground-fault protection.*

Important! *Install fuse and verify that power supply settings match local AC supply before use.*

To check or change the voltage setting

- 1 Disconnect the fixture from power. Remove the lamp access cover.
- 2 Set the 5-position switch to the setting closest to the AC voltage. Use the higher setting if the voltage is halfway between 2 settings. For example, use the 230 V setting instead of the 210 V setting for operation with 220 V power.
- 3 Set the 2-position switch to the AC frequency (50 / 60 Hz).
- 4 Replace the cover and apply a new power setting label to the serial number label.

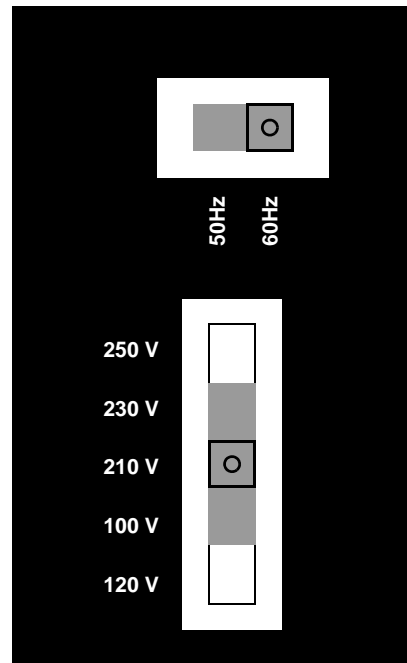

To install the main fuse

Fuses are provided for 100 - 130 V and 200 - 250 V operation. *Use only the fuse specified for the operating voltage.*

- 1 **Locate the bag containing the fuse for your AC voltage. Insert the fuse in the fuse holder. The holder may be packed with the other fuse.**
- 2 **Remove the label covering the mains input socket.**
- 3 **Insert the fuse holder in the empty slot in the mains input socket. See also “To replace the main fuse” on page 20.**

To install a plug on the power cable

The power cable must be fitted with a grounding-type cord cap that fits your power distribution system. Consult an electrician if you have any doubts about proper installation.

Important! ***Verify that the feed cables are undamaged and rated for the current requirements of all connected devices before use.***

- **Following the cord cap manufacturer’s instructions, connect the yellow and green wire to ground (earth), the brown wire to live, and the blue wire to neutral. The table below shows some pin identification schemes.**

Wire	Pin	Marking	Screw color
brown	live	“L”	yellow or brass
blue	neutral	“N”	silver
yellow/green	ground		green

INSTALLATION

4

The FiberSource QFX 150 can be fastened directly through the 4 rubber washers in the mounting flanges, or hung with 2 rigging clamps (not included) fastened through the 13 mm holes.

INSTALLATION REQUIREMENTS

For optimum performance and ease of service, install the fixture such that

- The long axis is horizontal as shown in A to right. This positions the lamp electrodes for maximum lamp life. Do not install as shown in B.
- The minimum clearance around the fans and air vents at both ends is 10 cm (4 in.) and circulation is adequate keep the air around the fixture at 40° C (104° F) or below.
- The DIP-switch is accessible and there is room to insert cables.
- The lamp access panel can be removed.
- All safety requirements are met.

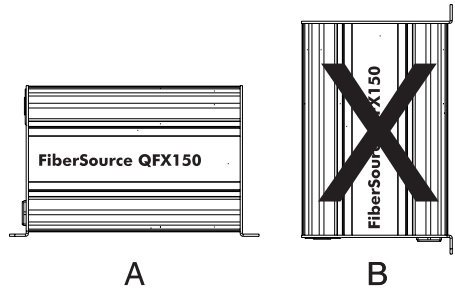

To install the FiberSource QFX 150

Warning! *Always use a secure means of secondary attachment when hanging the fixture with clamps.*

- 1 Verify that the fasteners or clamps can safely bear the fixture's weight. Verify that the structure can safely support the weight of all installed fixtures, clamps, cables, auxiliary equipment, etc.
- 2 Block access below the work area.
- 3 If fastening directly, place a metal washer over each rubber washer. The metal washer must be as wide as the rubber washer, or wider, to insure a secure hold. Fasten with 4 suitable fasteners 4 - 5 mm (5/32 - 3/16 in.) in diameter.

- 4 If clamping, bolt the clamps securely to the flanges with grade 8.8 (minimum) M12 bolts and lock nuts, or as recommended by the clamp manufacturer, through the 13 mm holes. Install a safety cable that can hold at least 10 times the weight of the fixture through one of the small holes and around the truss or pipe. Remove a rubber washer if necessary to thread the safety cable.
- 5 Verify that the fixture is located at least 0.1 meters (4 in.) from any combustible materials. Verify that the clearance around the fan and air vents is at least 0.1 meters (4 in.). Verify that there are no flammable materials nearby.

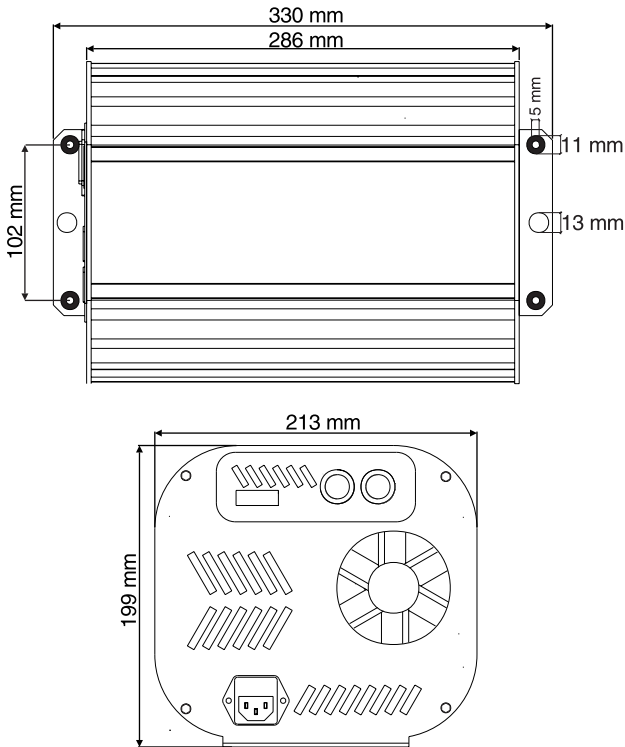

FIBER OPTIC CABLE

The FiberSource male adaptor for 50 - 300 strand cables, P/N 91611016 (not included), is tapered to fit fiber optic cables 8.3 - 19.3 mm (5/16 - 3/4 in.) in diameter. With cables over 8.3 mm in diameter, the adaptor must be shortened for proper fit and maximum light output. Please follow the instructions included with the fiber adaptor.

CABLE CONNECTION

The following guidelines provide a starting point for estimating your needs. Light transmission through fiber-optic cable depends on its quality and results will vary depending on the type of cable used.

SIDE-EMITTING CABLE

With 1 fixture, best results are had when the fiber optic cable is 10 m (33 ft.) or shorter. The length may be increased to 15 m (50 ft.) by looping the cable and illuminating both ends. With 2 fixtures, one at each end of the cable, lengths up to 30 m (100 ft.) can be achieved.

END-EMITTING CABLE

Light output decreases with length: keep the cable as short as possible. The maximum recommended length is 25 meters. Cut the light emitting end of the fibers with a sharp knife for maximum output.

To install fiber optic cable

- 1 Install the cable in the fiber adaptor according to the instructions packaged with the adaptor.**
- 2 Insert the adaptor fully into the fiber optic cable socket.**
- 3 Tighten the set screw with a 2 mm (5/64 in.) Allen wrench.**

CONTROLLER OPERATION

This FiberSource QFX 150 may be operated with any DMX-512 protocol controller.

DATA CONNECTION

A reliable data connection begins with the right cable. Standard microphone cable cannot transmit DMX data reliably over long runs. For best results, use cable specifically designed for RS-485 applications. Your Martin dealer can supply high quality cable in various lengths.

The FiberSource QFX 150's data sockets are wired pin 1 to ground, pin 2 to signal - (cold), and pin 3 to signal + (hot). This is the standard pin assignment for DMX devices.

One or more adaptor cables may be required to connect the fixture to the controller and other devices because many devices have 5-pin connectors and others may have reversed signal polarity, that is, pin 2 hot and pin 3 cold.

5-pin to 3-pin Adaptor	
Male	Female
1	1
2	2
3	3
4	
5	
P/N 11820005	

3-pin to 5-pin Adaptor	
Male	Female
1	1
2	2
3	3
	4
	5
P/N 11820004	

3-pin to 3-pin Phase-Reversing Adaptor	
Male	Female
1	1
2	3
3	2
P/N 11820006	

To connect the data link

- 1 Connect a data cable to the controller's data output. If controller has a 5-pin output, use a 5-pin male to 3-pin female adaptor cable (P/N 11820005).
- 2 Lead the data cable from the controller to the first fixture and plug the cable into the data input.

- 3 Connect the output of the fixture closest to the controller to the input of the next fixture. If connecting to a fixture with reversed-polarity (pin 3 cold), insert a phase-reversing cable between the two fixtures.
- 4 Continue connecting fixtures output to input. Up to 32 devices may be connected on a serial link.
- 5 Terminate the link by inserting a male termination plug (P/N 91613017) into the data output of the last fixture. A termination plug is simply an XLR connector with a 120 ohm, 0.25 W resistor soldered across pins 2 and 3.

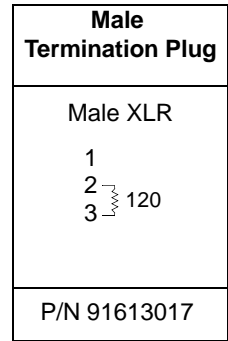

ADDRESS SELECTION

A control address must be set using the DIP-switch on the rear panel. The control address, also known as the start channel, is the first channel used to receive instructions from the controller. The FiberSource QFX 150 uses 5 DMX channels.

Each fixture must be assigned its own address and non-overlapping control channels for individual control. Two FiberSource QFX 150s may share the same address, but they will respond identically and individual control will not be possible.

Important! Disconnect the fixture from power before changing the DIP-switch setting. Changes take effect after the fixture has been turned off and back on.

To set the address

- 1 Select an address for the fixture between 1 and 508 on your controller.
- 2 Look up the DIP-switch setting for the address on page 14.
- 3 Disconnect the fixture from power.
- 4 Set pins 1 through 9 to the ON (1) or OFF (0) position as listed in the table.
- 5 Set pin 10 to the OFF position.

DIP-SWITCH ADDRESS TABLE

Find the address in the table below. Read the settings for pins 1 - 5 to the left and read the settings for pins 6 - 9 above the address. "0" means OFF and "1" means ON.

Important! Pin 10 must be OFF for controller operation.

DIP-Switch Setting					#9	0	0	0	0	0	0	0	0	1	1	1	1	1	1	1
0 = OFF					#8	0	0	0	0	1	1	1	1	0	0	0	0	1	1	1
1 = ON					#7	0	0	1	1	0	0	1	1	0	0	1	1	0	0	1
#1	#2	#3	#4	#5	#6	0	1	0	1	0	1	0	1	0	1	0	1	0	1	
0	0	0	0	0																
1	0	0	0	0	1	32	64	96	128	160	192	224	256	288	320	352	384	416	448	480
0	1	0	0	0	2	33	65	97	129	161	193	225	257	289	321	353	385	417	449	481
1	1	0	0	0	3	34	66	98	130	162	194	226	258	290	322	354	386	418	450	482
0	0	1	0	0	4	35	67	99	131	163	195	227	259	291	323	355	387	419	451	483
1	0	1	0	0	5	36	68	100	132	164	196	228	260	292	324	356	388	420	452	484
0	1	1	0	0	6	37	69	101	133	165	197	229	261	293	325	357	389	421	453	485
1	1	1	0	0	7	38	70	102	134	166	198	230	262	294	326	358	390	422	454	486
0	0	0	1	0	8	39	71	103	135	167	199	231	263	295	327	359	391	423	455	487
1	0	0	1	0	9	40	72	104	136	168	200	232	264	296	328	360	392	424	456	488
0	1	0	1	0	10	41	73	105	137	169	201	233	265	297	329	361	393	425	457	489
1	1	0	1	0	11	42	74	106	138	170	202	234	266	298	330	362	394	426	458	490
0	0	1	1	0	12	43	75	107	139	171	203	235	267	299	331	363	395	427	459	491
1	0	1	1	0	13	44	76	108	140	172	204	236	268	300	332	364	396	428	460	492
0	1	1	1	0	14	45	77	109	141	173	205	237	269	301	333	365	397	429	461	493
1	1	1	1	0	15	46	78	110	142	174	206	238	270	302	334	366	398	430	462	494
0	0	0	0	1	16	47	79	111	143	175	207	239	271	303	335	367	399	431	463	495
1	0	0	0	1	17	48	80	112	144	176	208	240	272	304	336	368	400	432	464	496
0	1	0	0	1	18	49	81	113	145	177	209	241	273	305	337	369	401	433	465	497
1	1	0	0	1	19	50	82	114	146	178	210	242	274	306	338	370	402	434	466	498
0	0	1	0	1	20	51	83	115	147	179	211	243	275	307	339	371	403	435	467	499
1	0	1	0	1	21	52	84	116	148	180	212	244	276	308	340	372	404	436	468	500
0	1	1	0	1	22	53	85	117	149	181	213	245	277	309	341	373	405	437	469	501
1	1	1	0	1	23	54	86	118	150	182	214	246	278	310	342	374	406	438	470	502
0	0	0	1	1	24	55	87	119	151	183	215	247	279	311	343	375	407	439	471	503
1	0	0	1	1	25	56	88	120	152	184	216	248	280	312	344	376	408	440	472	504
0	1	0	1	1	26	57	89	121	153	185	217	249	281	313	345	377	409	441	473	505
1	1	0	1	1	27	58	90	122	154	186	218	250	282	314	346	378	410	442	474	506
0	0	1	1	1	28	59	91	123	155	187	219	251	283	315	347	379	411	443	475	507
1	0	1	1	1	29	60	92	124	156	188	220	252	284	316	348	380	412	444	476	508
0	1	1	1	1	30	61	93	125	157	189	221	253	285	317	349	381	413	445	477	509
1	1	1	1	1	31	62	94	126	158	190	222	254	286	318	350	382	414	446	478	510
						63	95	127	159	191	223	255	287	319	351	383	415	447	479	511

CONTROLLABLE EFFECTS

LAMP POWER AND RESET

The lamp on command is on channel 1, the address channel. *When set up for controller operation, the lamp remains off until a lamp-on command is sent.*

A peak of electric current many times the operating current is drawn briefly when striking a lamp. Striking many discharge lamps at once may cause a voltage drop that prevents lamps from striking or trips circuit breakers. When striking multiple fixtures, space lamp on commands at 5 second intervals.

The lamp can be turned off as well, but then it must be allowed to cool for several minutes before it can be turned back on. To prevent accidental lamp off commands, this command only works when the dimmer is closed (ch. 2 < 3) and the twinkle effect is rotating slowly CCW (ch. 4 > 252). If a hot lamp does not strike, send the lamp off command and wait several minutes before trying again.

All effects reset to their home positions when the fixture is powered up. There is also a reset command on channel 1. To prevent accidental resets, the command must be sent for 5 seconds.

DIMMER

The intensity of the light is controlled from full-off to full-on on channel 2.

COLOR

The color wheel is controlled on channel 3. You can program split-color effects with continuous scroll, stick to full color positions using stepped scroll, and rotate the wheel continuously. The speed at which colors fade from one position to another can be controlled on channel 5, the speed channel.

TWINKLE

The speed and direction of the twinkle effect is controlled on channel 4. When stopped, the effect wheel returns to its home position where there is a removable section. The light output can be made more uniform if the twinkle effect is not used by removing this section.

FADE SPEED

Channel 5 controls the speed of the color wheel, allowing you to achieve variable fades on controllers without cross-faders. If your controller has cross-faders, and you use them, then set channel 5 to 0 (tracking), for best results.

STAND-ALONE OPERATION

7

CONTROL OPTIONS

The FiberSource QFX 150 can be operated without a controller in stand-alone mode. This mode provides various combinations of color and twinkle effect that are selected using DIP-switch pins 1 - 7.

The twinkle effect may be set to off, slow, medium, or fast using DIP-switch pins 1 and 2. If the twinkle effect is not required, a section of the effect wheel can be removed to increase the uniformity of the output: refer to “To remove or replace the twinkle wheel section” on page 19.

The speed at which the color wheel moves from one color to the next may be set to snap, slow, medium, or fast using DIP-switch pins 3 and 4. This setting has no effect if white or color 1 is selected.

The color or colors are selected using DIP-switch pins 5, 6, and 7. You can select white, color 1 (position 1), a range of colors, and continuous rotation. If continuous color wheel rotation is selected, then the color change speed must be slow, medium, or fast.

If a range of colors is selected, the color wheel holds at position 1 for 1 second, moves to position 2 at the selected change speed, holds for 1 second, and so on. When the last position is reached, the color wheel reverses direction. Colors can be arranged in any order as described under “To change color filters” on page 19.

To set stand-alone behavior

- 1 Disconnect the fixture from power.**
- 2 Set DIP-switch pins 1 - 7 on or off as shown in the table below to achieve the desired combination of effects.**
- 3 Pins 8 and 9 may be set to any combination to delay the lamp strike up to 4 seconds.**
- 4 Set pin 10 to on.**
- 5 Apply power to the fixture.**

The option setting will take effect and the lamp will automatically strike. Note, however, that a hot lamp must cool for several minutes before it can be restruck. If

the lamp does not strike, disconnect the fixture from power for several minutes to reduce strain on the starter while the lamp cools.

Important! DIP-switch pin 10 must be ON for stand-alone operation.

0 = OFF 1 = ON	pin 1	pin 2	pin 3	pin 4	pin 5	pin 6	pin 7	pin 8	pin 9	pin 10
	Setting									
no twinkle	0	0								1
slow twinkle	1	0								1
medium twinkle	0	1								1
fast twinkle	1	1								1
snap color change			0	0						1
slow color change			1	0						1
medium color change			0	1						1
fast color change			1	1						1
white					0	0	0			1
color 1					1	0	0			1
color 1 - 2					0	1	0			1
color 1 - 4					1	1	0			1
color 1 - 6					0	0	1			1
color 1 - 8					1	0	1			1
color 1 - 9					0	1	1			1
continuous rotation*					1	1	1			1

* Continuous rotation is not available when snap color change is selected.

MASTER/SLAVE OPERATION

Up to 32 FiberSource QFX 150s may be connected together for synchronous operation without a controller. They are connected together and one, the master, is set up in stand-alone mode and sends control instructions to the others.

Note: A peak of electric current many times the operating current is drawn briefly when striking a discharge lamp. *Striking many lamps at once may cause a voltage drop that prevents lamps from striking or trips circuit breakers.* To avoid this when operating multiple fixtures, stagger the lamp strikes by setting the slaves's DIP-switches to "addresses" from 0 - 15. For best results, divide the addresses evenly among the slave fixtures.

Important *Verify that all slave fixtures are set as described. Damage can be caused if there is more than 1 device (master fixture or controller) sending control signals on the serial data link.*

To connect and set fixtures for master/slave operation

- 1 Disconnect all fixtures from power.
- 2 Plug a 3-pin XLR data cable into the OUT socket of the first fixture and the IN socket of the next fixture.
- 3 Continue connecting fixtures output to input. Up to 32 FiberSource QFX 150s may be connected.
- 4 Insert a female termination plug into the IN socket of the first fixture. Insert a male termination plug into the OUT socket of the last fixture.
- 5 Select one fixture to be the master. Set desired stand-alone options using the master's DIP-switch as described on page 16.
- 6 Stagger the lamp strikes by setting the slaves to "addresses" between 0 and 15. Set DIP-switch pins 1 - 4 on each slave as shown on page 14 to select an address. Set the remaining DIP-switch pins to the OFF position.
- 7 Apply power to the fixtures.

Female Termination Plug
Female XLR 1 2 3 <small>1-120</small>
P/N 91613018

BASIC SERVICE

The FiberSource QFX 150 requires simple routine maintenance. The maintenance schedule depends heavily on the operating environment; please consult a Martin service technician for recommendations.

Any service procedure not described here should be referred to a qualified technician.

Warning! *Disconnect the fixture from power before removing any cover.*

Important! *Excessive dust, grease, and smoke fluid buildup degrades performance and causes overheating and damage to the fixture that is not covered by the warranty.*

To change color filters

- 1 Disconnect the fixture from power. Remove the lamp access cover.
- 2 Turn the color wheel by hand until the desired filter is accessible.
- 3 Using a soft cloth or gloves, gently tilt the outside edge of the filter back towards the lamp to unlock. Remove filter.
- 4 To place a filter in the wheel, insert the plastic holder between the spring clip with the protruding tab facing forwards until it snaps into place.
- 5 Replace the lamp access cover before applying power.

To remove or replace the twinkle wheel section

The twinkle wheel has a removable section for uniform light output when the effect is not used.

- 1 Disconnect the fixture from power. Remove the lamp access cover.
- 2 Turn the twinkle wheel by hand until the removable section is aligned with the cable socket. Turn the color wheel so that the open position is aligned with the cable socket.
- 3 Support the twinkle wheel with one hand and unlock the removable section by pulling the outside edge back towards the lamp. Grasp the section and pull it up and out.
- 4 To replace the section, turn the wheel to the open position and slide the section between the wheel and the spring clip, with the heads of the screws towards

the cable socket. Center the section and then support the wheel with a finger from the front as you press the 2 screw heads through the wheel.

- 5 Replace the lamp access cover before applying power.

To clean optical components

Use care when cleaning optical components. The surface of the color filters is fragile and small scratches may be visible.

- 1 Disconnect the fixture from power and allow it to cool completely. Remove the lamp access cover.
- 2 Blow or vacuum away loose dust. Remove residues from filters with a soft cloth or cotton swabs wetted with isopropyl alcohol. Regular glass cleaner may also be used, but no residues may remain.
- 3 Rinse with distilled water. Mixing the water with a small amount of wetting agent such as Kodak Photoflo will help prevent streaking and spotting.
- 4 Dry with a clean, soft and lint-free cloth or blow dry with compressed air.

To clean the fan and air vents

To maintain adequate cooling, dust must be cleaned from the fan and air vents periodically.

- 1 Disconnect the fixture from power.
- 2 Remove dust and dirt from the fan blades and vent grills using a soft brush, cotton swab, vacuum, or compressed air.

To replace the main fuse

- 1 Unplug the mains cable from the input socket. Pry open the fuse holder as shown.
- 2 Remove the defective fuse and replace it with one of the same type and rating.
- 3 Replace the fuse holder in the mains input socket.

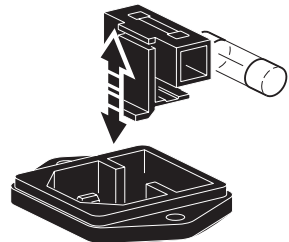
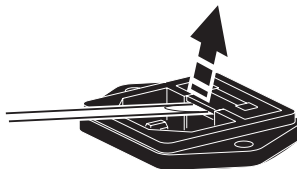
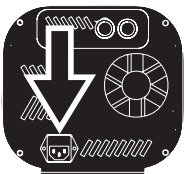

To replace the secondary fuse

- 1 Disconnect the fixture from power.
- 2 Remove one screw by the DIP-switch and one screw by the data IN socket.
- 3 Pull the circuit board assembly out until you can access the fuse, which is located behind the data IN socket.
- 4 Remove the defective fuse and replace it with one of the same type and rating.
- 5 Replace the circuit board assembly before applying power.

TROUBLESHOOTING

10

Problem	Probable cause(s)	Remedy
Fixture is completely dead.	No power to fixture.	Check that power is switched on and cables are plugged in.
	Primary fuse blown.	Replace fuse.
	Secondary fuse blown.	Replace fuse.
Fixture resets correctly but does not respond to the controller.	The controller is not connected.	Connect controller.
	Reversed data signal polarity.	Install a phase-reversing cable between the controller and the fixture.
	Bad data link connection	Inspect connections and cables. Repair or replace damaged cables.
	Data link not terminated.	Insert termination plug in output of the last fixture on the link.
	Incorrect address setting.	Check DIP-switch settings.
	One of the fixtures is transmitting as a master or is defective.	Bypass one fixture at a time until normal operation is regained; unplug both cables from fixture and connect them directly together. Contact Martin technician for service.
Fixture fails to reset correctly.	An effect requires mechanical adjustment.	Contact Martin technician for service.
No light.	Lamp too hot to strike.	Allow lamp to cool.
	Power settings do not match AC supply.	Check AC setting.
	Defective lamp.	Replace lamp.
Lamp cuts out intermittently or burns out too quickly.	Fixture is too hot.	Allow fixture to cool.
	Power settings do not match AC supply.	Check settings.
	Defective fan.	Contact Martin technician for service.

DMX PROTOCOL



Channel	Value	Percent	Function	
1	0 - 89	0 - 35	Reset and lamp power	
	90 - 119	35 - 46	No function	
	120 - 149	47 - 58	Reset (time > 5 sec.)	
	150 - 199	59 - 78	No function	
	200 - 249	78 - 98	Lamp on	
	250 - 255	98 - 100	No function Lamp off (w/ Ch. 2 < 3 & Ch. 4 > 252)	
2	0 - 255	0 - 100	Dimmer	
			Closed to Open	
3	0 - 144	0 - 56	Color Wheel	
			Continuous scroll	
			Open	
			Color 1 (blue 108)	
			Color 2 (green 206)	
			Color 3 (yellow 603)	
			Color 4 (red 308)	
			Color 5 (-)	
			Color 6 (-)	
			Color 7 (-)	
	Color 8 (-)			
	Color 9 (-)			
	145 - 185	57 - 72	57 - 72	Stepped scroll
				Color 9 (-)
				Color 8 (-)
				Color 7 (-)
				Color 6 (-)
				Color 5 (-)
				Color 4 (red 308)
				Color 3 (yellow 603)
Color 2 (green 206)				
Color 1 (blue 108)				
Open				
186 - 220	73 - 86	73 - 86	Continuous rotation	
			CW, fast to slow	
221 - 255	87 - 100	87 - 100	CCW, slow to fast	
4	0 - 1	0	Twinkle Wheel	
			Stop/Open	
			CW, slow to fast	
			Stop	
126 - 131	49 - 51	49 - 51	Stop	
			CCW, fast to slow	
132 - 255	52 - 100	52 - 100	CCW, fast to slow	
5	0 - 2	0	Color Speed	
			Tracking (speed function off)	
			Fast speed with shortcut enabled	
			Fast to slow, shortcut disabled	
3 - 5	1	1		
6 - 255	2 - 100	2 - 100		

Start code = 0

FiberSource QFX150 DMX Protocol

Implemented from software version 1.0

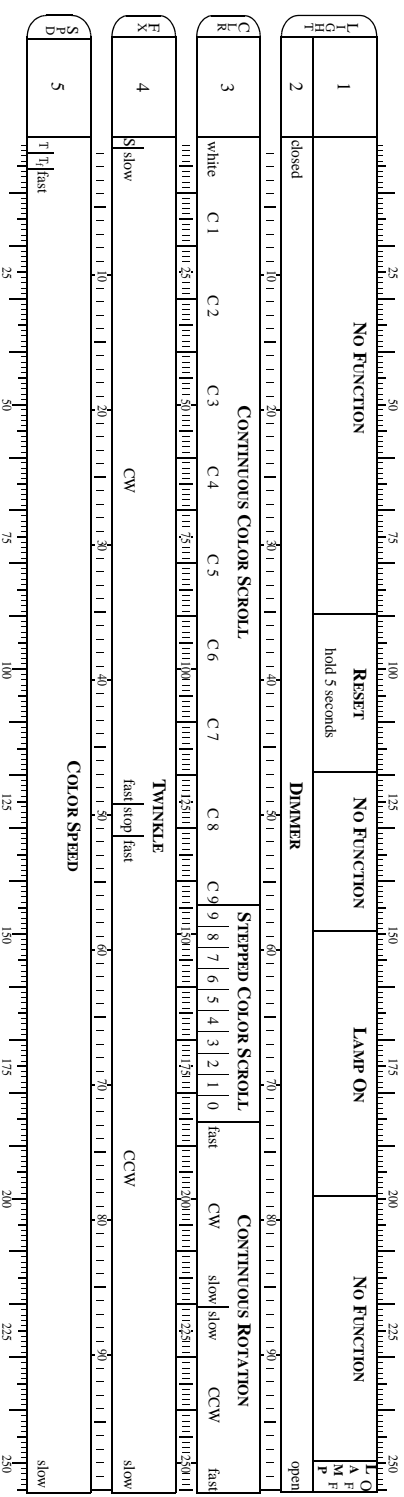

* Close dimmer and set channel 4 to full to enable lamp off.

T = tracking mode (speed function off)

T_r = tracking mode with shortcuts

SPECIFICATIONS

PHYSICAL

Length: 330 mm (13.0 in)
Width: 213 mm (8.4 in)
Height: 199 mm (7.8 in)
Weight: 10.4kg (lbs)

SOURCE

Osram HQI-R 150 (included): 150 W, 6000 hr., 4200K

CONTROL

Control options:DMX-512, stand-alone, master/slave
DMX channels: 5
Data I/O: locking 3-pin XLR, pin 1 shield, pin 2 cold (-), pin 3 hot (+)
Recommended cable: ... 24 AWG (min.), low capacitance, 85-150 Ω shielded twisted pair

INSTALLATION

Orientation: horizontal
Minimum distance to combustible materials:0.1 m (4 in)
Minimum clearance around fan and air vents:0.1 m (4 in)

AC SUPPLY

Power supply options: 100/120/210/230/250 V, 50/60 Hz (switch-selectable)
Maximum power and current: 205W, 1.9A @ 120V; 195W, 1.0A @ 230V

FUSES

Primary fuse: T 3.15 A, high I²t, 250 V, P/N 05020013
Secondary fuse: T 2.0 A, 250 V, P/N 05020009

CONSTRUCTION

Housing: sheet steel and aluminum
Finish: black, electrostatic powder coating
Protection factor: IP 20

ACCESSORIES

C

Male adaptor for 50 - 300 strand cables with installation materials:	P/N 91611016
G-clamp:	P/N 91602003
Half-coupler clamp:	P/N 91602005
Accessory color filter, blue 111:	P/N 62327015
Accessory color filter, blue 101:	P/N 62327016
Accessory color filter, cyan 401:	P/N 62327017
Accessory color filter, green 202:	P/N 62327018
Accessory color filter, yellow 604:	P/N 62327019
Accessory color filter, red 301:	P/N 62327021
Accessory color filter, pink 312:	P/N 62327022
Accessory color filter, magenta 507:	P/N 62327023
Accessory color filter, purple 502:	P/N 62327025
Accessory color filter, green 204:	P/N 62327034
Accessory color filter, orange 306:	P/N 62327035