

SHARK[®] DSP110

Users's Manual

Version 1.2 April 2001

ENGLISH

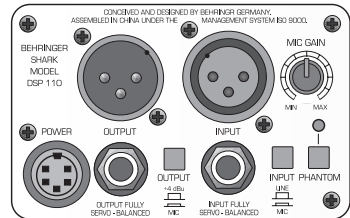
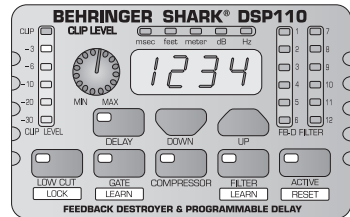

www.behringer.com

SAFETY INSTRUCTIONS

CAUTION: To reduce the risk of electrical shock, do not remove the cover (or back). No user serviceable parts inside; refer servicing to qualified personnel.



WARNING: To reduce the risk of fire or electrical shock, do not expose this appliance to rain or moisture.



This symbol, wherever it appears, alerts you to the presence of uninsulated dangerous voltage inside the enclosure - voltage that may be sufficient to constitute a risk of shock.



This symbol, wherever it appears, alerts you to important operating and maintenance instructions in the accompanying literature. Read the manual.

DETAILED SAFETY INSTRUCTIONS:

All the safety and operation instructions should be read before the appliance is operated.

Retain Instructions:

The safety and operating instructions should be retained for future reference.

Heed Warnings:

All warnings on the appliance and in the operating instructions should be adhered to.

Follow instructions:

All operation and user instructions should be followed.

Water and Moisture:

The appliance should not be used near water (e.g. near a bathtub, washbowl, kitchen sink, laundry tub, in a wet basement, or near a swimming pool etc.).

Ventilation:

The appliance should be situated so that its location or position does not interfere with its proper ventilation. For example, the appliance should not be situated on a bed, sofa rug, or similar surface that may block the ventilation openings: or placed in a built-in installation, such as a bookcase or cabinet that may impede the flow of air through the ventilation openings.

Heat:

The appliance should be situated away from heat sources such as radiators, heat registers, stoves, or other appliances (including amplifiers) that produce heat.

Power Source:

The appliance should be connected to a power supply only of the type described in the operating instructions or as marked on the appliance.

Grounding or Polarization:

Precautions should be taken so that the grounding or polarization means of an appliance is not defeated.

Power-Cord Protection:

Power supply cords should be routed so that they are not likely to be walked on or pinched by items placed upon or against them, paying particular attention to cords and plugs, convenience receptacles and the point where they exit from the appliance.

Cleaning:

The appliance should be cleaned only as recommended by the manufacturer.

Non-use Periods:

The power cord of the appliance should be unplugged from the outlet when left unused for a long period of time.

Object and Liquid Entry:

Care should be taken so that objects do not fall and liquids are not spilled into the enclosure through openings.

Damage Requiring Service:

The appliance should be serviced by qualified service personnel when:

- The power supply cord or the plug has been damaged; or
- Objects have fallen, or liquid has been spilled into the appliance; or
- The appliance has been exposed to rain; or
- The appliance does not appear to operate normally or exhibits a marked change in performance; or
- The appliance has been dropped, or the enclosure damaged.

Servicing:

The user should not attempt to service the appliance beyond that which is described in the Operating Instructions. All other servicing should be referred to qualified service personnel.

1. INTRODUCTION

Thank you very much for expressing your confidence in BEHRINGER products by purchasing the SHARK DSP110.



This manual first describes the terminology used, so that you can fully understand the DSP110 and its functions. Please read the manual carefully and keep it for future reference.

1.1 The concept

With the SHARK DSP110 you purchased a device that combines an automatic Feedback Destroyer using the ingenious search algorithms of our FEEDBACK DESTROYER PRO DSP1124P, a variable Delay Line (adjustable in msec, feet and meter), a ULN (Ultra-Low Noise) microphone pre-amp with Phantom Power, an automatic Noise Gate, a variable Low Cut filter and a Compressor—all in one ultra-rugged and compact case. Still, the SHARK can be operated intuitively and expanded to a multi-channel system using another four SHARKs and an optionally available 19" rack mount kit. The SHARK's 24-bit A/D and D/A converters guarantee a precise reproduction of your program material.

High volume levels and the use of ever more sophisticated monitoring systems with a multitude of speaker cabinets have led to a greater potential risk of feedback loops in sound reinforcement systems. So far, audio engineers have been using conventional 1/3-octave equalizers to suppress unwanted feedback. However, the individual filters of such an EQ, with their relatively wide bandwidth, have quite an impact on the sound image. With the BEHRINGER SHARK (minimum bandwidth: 1/60 of an octave) you are now free to either choose the trial and error method to suppress feedback with graphic equalizers, or to assign this task to the DSP110, so that you can give your music your undivided attention. Using extremely narrow-bandwidth filters, the SHARK DSP110 eliminates only unwanted feedback, without affecting your music.

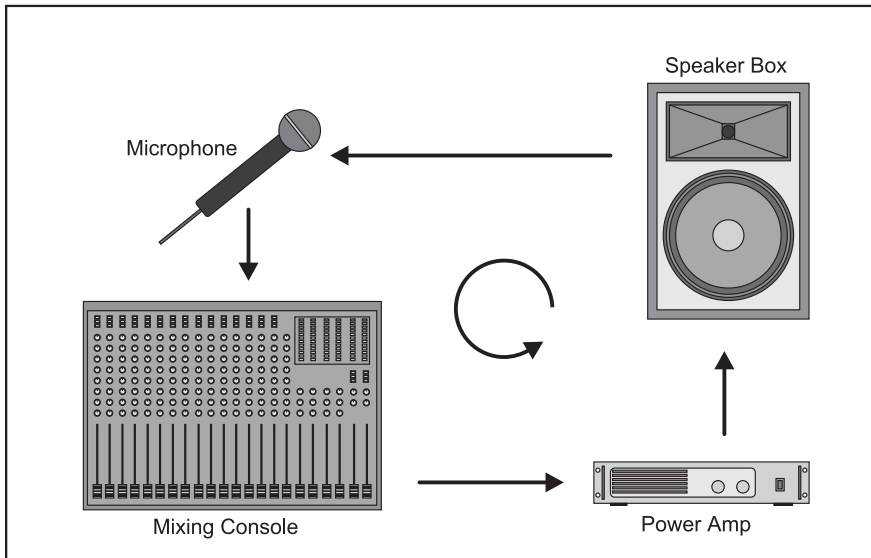



Fig. 1.1: Typical feedback loop

1.2 Before you begin

Your SHARK was carefully packed in the factory and the packaging is designed to protect the unit from rough handling. Nevertheless, we recommend that you carefully examine the carton and its contents for any signs of physical damage, which may have occurred during transit.

 **If the unit is damaged, please do not return it to BEHRINGER, but notify your dealer and the shipping company immediately, otherwise claims for damage or replacement may not be granted. Shipping claims must be made by the consignee.**

The optionally available rack mount kit allows you to mount your BEHRINGER SHARK in a standard 19" rack, together with another four SHARKs. The rack mount kit requires 2U of rack space.

Be sure that there is enough air space around the unit for cooling and please do not place the SHARK on high-temperature devices such as power amps, etc. to avoid overheating.

Please use the enclosed power supply to connect the unit to the mains. The supply complies with all applicable safety standards.

 **Please note that all units must be grounded properly. For your own safety, you should never remove any ground connectors from electrical devices or power cords or render them inoperative.**

Further information can be found in chapter 3 "INSTALLATION".

As a standard the audio inputs and outputs of the BEHRINGER SHARK DSP110 are fully balanced. If possible, connect the unit to other devices in a balanced configuration to allow for maximum interference immunity. The automatic servo function detects unbalanced connections and compensates the level difference automatically (6 dB correction).

1.3 Control elements

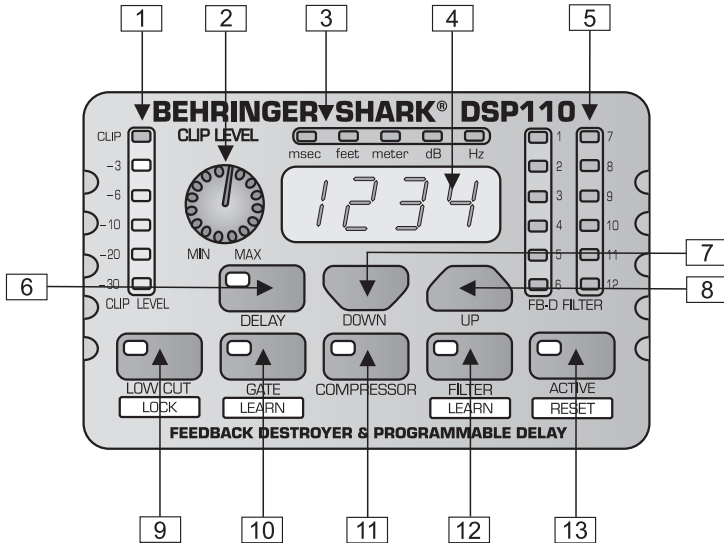



Fig. 1.2: Front panel control elements of the DSP110

- 1 The **CLIP LEVEL METER** shows you whether or not the digital circuitry is driven correctly. Any corrections can be made with the **CLIP LEVEL** control 2. Be sure that the **CLIP LED** won't light up.
 - 2 The **CLIP LEVEL** control lets you adapt the internal gain optimally to the digital circuitry. If gain is too high (**CLIP LED** lights up), raise the **CLIP LEVEL** value by turning the control to the right (and vice versa). Thus, you can shift the operating level upwards/downwards.
-  **The CLIP LEVEL control does not affect the input/output levels, but adapts the audio signal as optimally as possible to the threshold of the digital circuitry.**
- 3 These five **LEDs** symbolize the units of the parameters that can be adjusted on the display 4.

- 4 The 4-digit *DISPLAY* reads the absolute values of the adjusted parameters.
- 5 The *FB-D FILTER STATUS LEDs* display the status of each of the 12 individual filters. The SHARK uses four different filter modes:
- ▲ **Disabled filters** (which can be re-enabled with the *ACTIVE* button). When a filter is off, its LED is not lit.
 - ▲ **Free filters** which automatically search for feedback frequencies and whose activity is shown by a flashing LED.
 - ▲ **Set filters** which can be reconfigured as free (searching) filters, when all filters are currently in use.
 - ▲ **Permanently set filters** which must be *RESET* to be reconfigured as free filters.
- Once a filter has been set, its LED lights up.**
- 6 The *DELAY* button allows you to adjust the Delay Line time. Press the button several times to either choose msec, feet or meter. The last unit selected will be stored and recalled next time you use the *DELAY* function. The control LED lights up while you are making your entries. The setting range is from 0 to 2,500.0 msec, 0 to 2,818.2 feet, and 0 to 859.00 meters. When you are using high values, the 4-digit display reads the last figure only when you start editing with the *UP/DOWN* buttons. Example: for a value of 1,500.0 msec, the display reads "1500" when you press the *DELAY* button, and "500.0" when you start editing. In this way, you can use extremely small steps when editing parameters.
-  **To speed up the selection, briefly press the key located next to the *UP* or *DOWN* key. The selection speed will be increased with each additional key press. This function can be used for all parameter edits.**
- 7 The *DOWN* button lowers the parameter values shown in the display 4.
- 8 The *UP* button raises these parameter values.

- 9 The *LOW CUT* button lets you enter the high pass filter's cut-off frequency (20 to 150 Hz). When set to OFF the filter is inoperative. The control and "Hz" LEDs light up while you are entering a value. Use the UP/DOWN buttons to edit. Pressing the LOW CUT button for a longer time (please wait, until all five parameter LEDs light up) enables the keypad lock feature which prevents inadvertent editing of parameters and settings. When the keypad lock is enabled, the LOW CUT key's control LED starts flashing.
- 10 Use the *GATE* button to adjust the threshold of the internal Noise Gate (-96 dB through -44 dB). When set to OFF, the Noise Gate is inoperative. The control LED of the GATE button lights up while you are entering a value. Pressing the GATE button for a longer time (please wait, until all five parameter LEDs light up) enables the GATE LEARN function, which automatically sets the Noise Gate threshold by analyzing the program material and adjusting the value accordingly (value detected plus 2 dB). In GATE LEARN mode, the GATE key's control LED starts flashing. As long as the LED flashes, the detected value is read on the display, when the LED stops flashing, the value is raised by +2 dB.
- 11 The *COMPRESSOR* button gives you access to two parameters that let you adapt the DSP110's Compressor function to the program material. Press the button once to adjust the DENSITY parameter, which controls the compression density from 0 (no processing) to 100 (maximum compression). Press the COMPRESSOR button a second time to adjust the SPEED parameter which controls the Compressor's attack and release times from 10 to 1000 msec. The "msec" LED lights up as soon as you select the SPEED parameter.
- 12 The *FILTER* key allows you to set the feedback detection sensitivity within a range from 1 (no sensitivity) through 100 (full sensitivity). The default value is 50. The control LED lights up during data entry. Briefly press the FILTER key a second time to edit the maximum attenuation of the FB-D filter (from -3 dB through -48 dB in steps of 3). Pressing the FILTER key longer (please wait, until all five parameter LEDs light up) activates the FILTER LEARN function, which automatically searches for feedback frequencies and assigns free filters to the frequencies found. Now you can enter the number of filters (standard: 9) to be used for permanent feedback suppression. Although the remaining filters are also used to eliminate feedback frequencies, they are released once new feedback occurs. Pressing the FILTER key once again activates the FILTER LEARN function.



When both FILTER LED and display stop flashing, the FILTER LEARN function has been completed. Press the FILTER key to cancel the function. After a short delay, the unit returns to the FILTER menu.

The FILTER LEARN function generates short feedback-causing signals that are sent back to the DSP110's input, where feedbacks are detected and suppressed. The FILTER LEARN function is an useful tool for live concerts that prevents filters from being released prematurely. Fixed filters can only be reconfigured as free, searching filters by means of a RESET. In normal mode, which is activated after power-up, set filters are automatically released one after the other, when free filters are needed to search and destroy feedback frequencies.



To ensure that the FILTER LEARN function works properly, the short feedback-causing signals are output with a level of -18 dB below digital maximum. However, the feedback caused during the FILTER LEARN procedure will be limited by the compressor to -30 dB below digital maximum. Please note that considerable volume levels can still occur, which is why you should use the FILTER LEARN function only before the concert/event begins.

13

Enable the *ACTIVE* button to set inoperative filters to automatic search mode. When this button is up (control LED is off), those filters are inoperative which have not yet found a feedback frequency. Pressing the ACTIVE button for a longer time (please wait, until all five parameter LEDs light up) enables the RESET function. All filters will be reset, i.e. set to automatic search mode.

SHARK DSP110

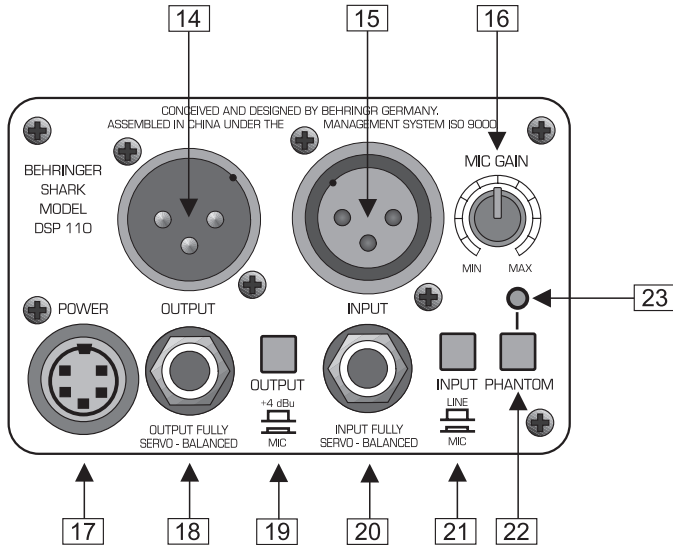

Fig 1.3: Rear panel control elements and connectors of the DSP110

- 14 This is the SHARK's balanced XLR output.
- 15 This is the SHARK's balanced XLR input.
- 16 The *MIC GAIN* control adjust the input signal gain, when the *INPUT LEVEL* switch 21 has been pressed (position: *MIC*). To adjust microphone levels you can use the *CLIP LEVEL* indicator, by setting the *CLIP LEVEL* control to mid-travel position. Please make sure that the *CLIP LED* will not light up.
- 17 Use the *POWER SUPPLY CONNECTOR* to hook up the SHARK's external power supply.
- 18 This is the SHARK's balanced JACK output, which carries the same signal as the XLR output.
- 19 The *OUTPUT LEVEL* switch controls the reference level provided by the outputs of the DSP110. Possible values are: +4 dBu or microphone level.

- 20 This is the SHARK's balanced *JACK* input, which is wired in parallel to the XLR input.
- 21 Use the *INPUT LEVEL* switch to select the input sensitivity (microphone or line levels). In *LINE* mode, you can use the *CLIP LEVEL* control to adapt the internal level settings to the digital circuitry. Please make sure that the *CLIP-LED* will not light up.
- 22 The *PHANTOM* switch enables the Phantom Power supply required for condenser microphones.
- 23 The *PHANTOM CONTROL LED* lights up when Phantom Power is on.

2. APPLICATIONS

2.1 Wiring the DSP110: general remarks

With its great versatility the SHARK can be used for a variety of applications. This chapter describes connection and configuration examples of the most common applications.

2.1.1 Connection between microphone and mixing console

In live applications it is often useful to protect specific single microphones against feedback. We therefore recommend that you connect the SHARK between your microphone and a microphone input on your mixing console (*OUTPUT LEVEL* switch set to *MIC*). If all mic inputs are in use, you can set the SHARK's *OUTPUT* switch to +4 dBu (switch pressed) and adapt the output signal of your SHARK to a line input on your console using the *MIC GAIN* control. To prevent the occurrence of subsonics you can activate the SHARK's Low Cut filter. Switch on Phantom Power when you are using condenser microphones.

SHARK DSP110

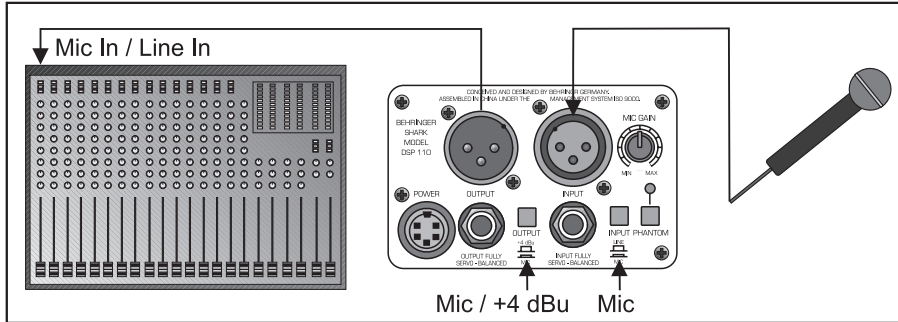

Fig. 2.1: The SHARK connected between microphone and microphone input on console

2.1.2 Connection between line-level source and mixing console

At first sight, this configuration may seem to make no sense, because line-level sources usually have no problems with feedback frequencies. However, acoustic instruments are often equipped with so-called piezo pickups which are susceptible to feedback. In such a case, we recommend that you route the audio signal through the SHARK before feeding it into the console.

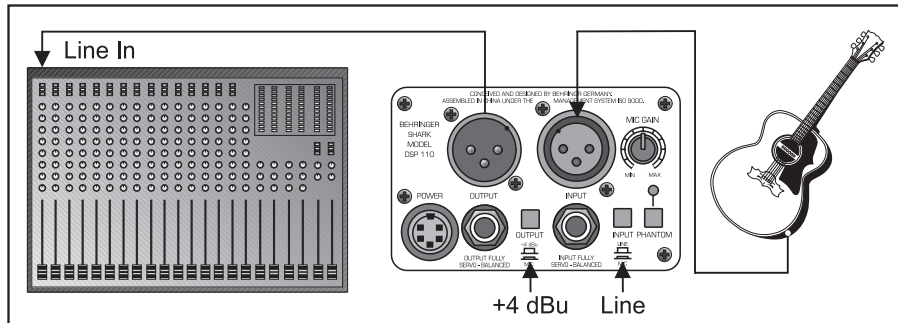

Fig. 2.2: The SHARK connected between acoustic guitar and line input on console

2.1.3 Connection between mixing console and power amplifier

When you use the SHARK as a Delay Line unit for speaker systems placed at various positions (see chapter 2.3), you should connect the SHARK between the console's output and the input of the power amp driving the "delayed" speakers.

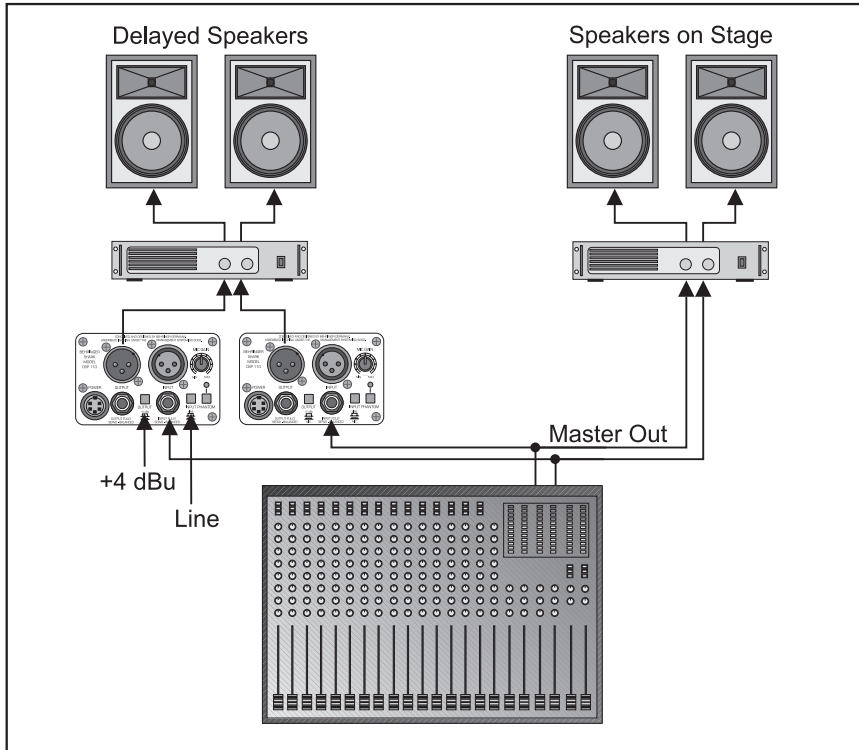

Fig. 2.3: The SHARK connected between console and power amp

2.1.4 The SHARK used in the monitor path

Inserting the DSP110 in the monitor path of your mixing console gives you utmost protection against unwanted feedback. Monitor paths are particularly susceptible to feedback, because on stage there are usually several microphones and speakers placed close to each other. Especially vocal microphones pose some problems, because their volume levels must be fairly high to be able to “compete” with other instruments, and often these microphones are hand-held and hence carried around on stage. It is therefore useful to protect the monitor path against feedback. In particular, when used in the monitor path, the SHARK produces a positive side effect in that it improves both sound and volume of the monitors. By filtering interference it makes the sound more transparent and by eliminating unwanted feedback it allows for raising the volume of the monitors, an effect that is usually welcomed by musicians on stage. Another advantage when using this configuration: one SHARK can control several microphones. As at least four monitor paths are used in a typical live application, all you need are four SHARKs to give you optimum feedback protection.

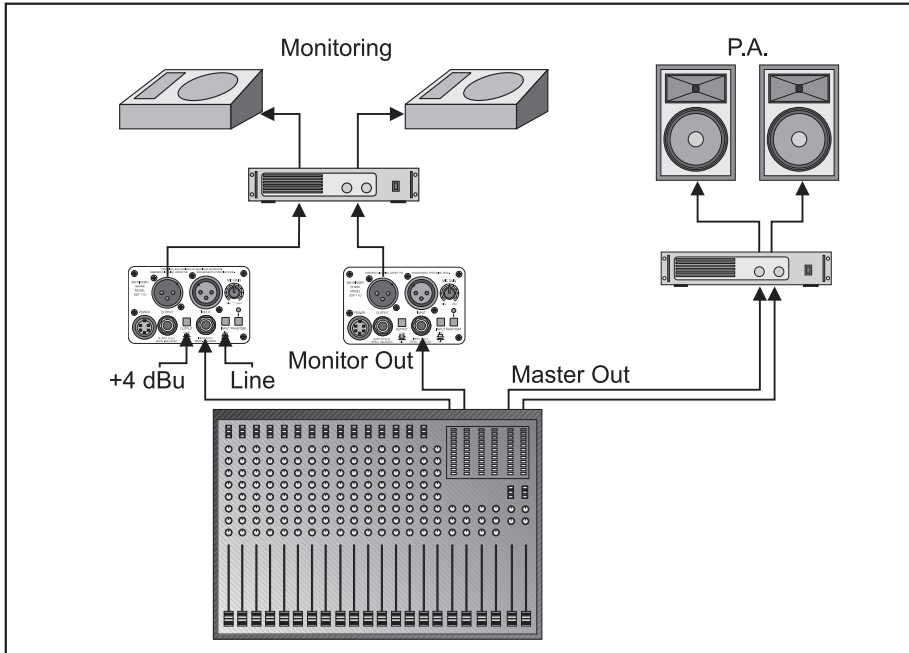

Fig. 2.4: Two SHARKs in the monitor path

2.1.5 The SHARK used in single channels and subgroups

Whenever you want to make sure that wanted feedback such as the feedback sounds produced by a guitar won't be removed, you should insert one or several DSP110 into "feedback-prone" single channels (e.g. vocals) or subgroups of your mixing console! Route all channels that are susceptible to feedback (e.g. all vocal mics) to one or several subgroups, in which you insert one or several SHARKs. In this way, all channels that are less liable to produce feedback (e.g. those carrying line-level signals, or instrumental microphones with lower volumes) can pass the console unaltered, while only critical microphone channels are controlled by the DSP110. Thus, you can protect your sound reinforcement system against feedback and still use wanted feedback sounds.

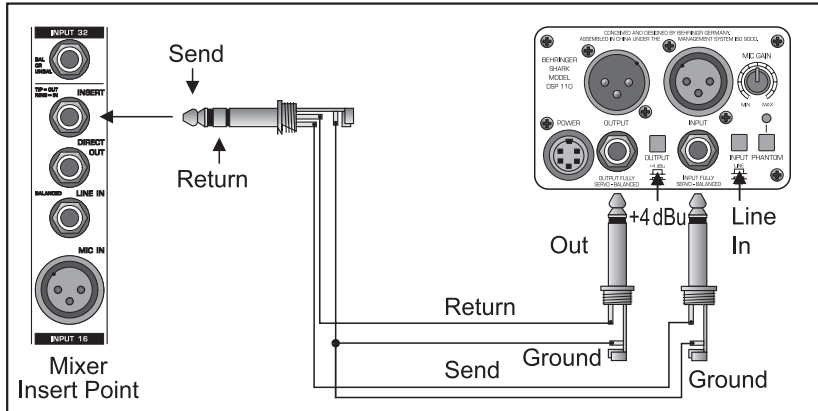

Fig. 2.5: The SHARK in the insert path

2.1.6 Automatic “tuning in” of P.A. and monitor systems

With the DSP110 you can improve the protection against feedback even before a concert begins, simply by “tuning in” your sound reinforcement system: once the system has been installed and set up, open all microphone channels and monitor paths, then enable FILTER LEARN mode on your DSP110. The SHARK generates short feedback-causing signals, which are then sent back to its input and suppressed by the filters. These filters are permanently assigned and can be reconfigured as free searching filters only by means of a RESET. Without the SHARK you could raise the overall volume level only until the first feedback occurs. But with the DSP110 you’ve got considerably more headroom! Please note that the FILTER LEARN mode is limited to about 15 seconds.

If you are using not just one DSP110 for the monitor path, you should employ some additional units to safeguard critical signal paths. Experience has shown that during a concert the musicians on stage usually want their instruments made louder in the monitors. With the SHARK you can raise the volume without running the risk of feedback. When the concert begins the DSP110 automatically tracks and removes varying feedback signals produced by “moving” vocal microphones.

2.2 The Feedback Destroyer in the SHARK

The SHARK identifies feedback by splitting the entire frequency spectrum (20 Hz to 20 kHz) into sections of 1/60 of an octave and determining the level of each of these bands. The values calculated are then referenced to the level of the overall signal. The resulting level difference determines whether or not a filter is set. The SHARK allows you to adapt these decisive parameter to your needs: within a range from 1 through 100 you can edit the feedback detection sensitivity. The standard setting is 50, which ensures the best possible detection of feedback for the majority of applications. For speech-only applications you can raise the feedback detection threshold towards 100, which enables the algorithm to detect and remove feedback even more quickly. Vice versa, lower values provide for a more stable feedback suppression responding less to wanted feedback-like signal portions produced by guitars or keyboards.

In FILTER LEARN mode, feedback is generated and suppressed automatically. Whenever it detects feedback, the DSP110 selects the filter parameters automatically to efficiently remove the feedback. As the filter is set to the frequency detected, this mode is ideally suitable for suppressing constant feedback frequencies produced by “fixed” microphones, e.g. those used on drums. Once set, the filters automatically enters lock mode, i.e. the frequency remains fixed but width and depth of the filter are still being adapted to the signal. The filter width is enlarged whenever the feedback frequency shifts slightly. If feedback persists, gain is reduced even more and kept low to prevent feedback from recurring.

All microphones that are moved during a performance (e.g. hand-held vocal microphones) are usually susceptible to varying feedback frequencies, which should be suppressed in automatic search mode (entered when you power up the SHARK). Much like in FILTER LEARN mode, a filter automatically determines the ideal settings for all parameters, in order to suppress feedback. However, once all filters have been set, the filter first activated gets reset to automatic search mode. Thus, the SHARK makes sure that there is always one free filter to identify and remove new feedback frequencies. If your music contains wanted feedback elements (e.g. guitar feedback), the SHARK will suppress these too, because it is impossible from a physical point of view to distinguish wanted from unwanted feedback. Section 2.1.6 provides some information on how to get around this physical problem.

2.3 The integrated Delay

In addition to speakers on or near the stage, major-scale installations often have speaker groups positioned at a distance to the stage or flown above the audience, in order to provide listeners away from the stage with direct sound. However, since sound needs some time to travel around (343.6 m/sec at 20°C, accelerates by 0.6 m/sec per °C), it reaches the audience not simultaneously but gets delayed by a certain amount. To make up for the different run times between stage and remote speakers, the latter must be provided with an electronically delayed signal, which is usually done by means of special-purpose Delay devices. You won't need them, however, when you've got a SHARK, as the DSP110 integrates a Delay Line circuit giving you the same convenience of operation as dedicated devices. Simply measure the distance between the various speaker groups and enter this value (in meters or feet). Chapter 2.1.3 shows you how to wire the DSP110 in this type of application.

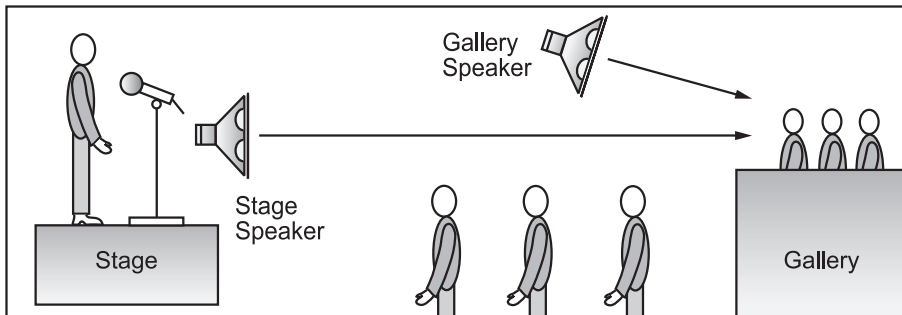

Fig. 2.6: Sound reinforcement application with different speaker positions

2.4 The Noise Gate function

The main task of a Noise Gate is to separate unwanted background noise from wanted signals and remove noise “inaudibly”. A so-called downward Expander automatically reduces the overall level of all signals below an adjustable threshold and thus expands the dynamic range of the program material.

In live or stage applications and multi-microphone systems, in particular, the SHARK has a variety of possible uses: as a moderately and accurately set Gate it efficiently suppresses background noise, compressor-induced noise build-up and crosstalk

between microphones, without producing any unpleasant side effects.

A typical Gate application is the processing of vocal tracks. Especially when using a Compressor, the distance between microphone and singer is critical: as the distance increases, more and more disturbing background noise is picked up. Use the Gate function to fade out unwanted interference “inaudibly” during music pauses. In live applications, e.g. crosstalk of drum and piano tracks can be suppressed or acoustically “contaminated” recordings can be cleaned.

When a singer sings into a stage microphone, the background noise is masked and hence not perceived. During music pauses, however, the microphone picks up the noise produced by the P.A. system and monitor speakers, which can lead to unpleasant feedback.

When you insert the SHARK in a vocal channel and adjust it so that it mutes the channel, as long as the microphone is not in use, susceptibility to feedback can be reduced enormously. Basically, all stage microphones should be treated in this way.

The GATE LEARN function helps you adjust the Gate threshold. Use this function before the concert and after the sound check. If the adjusted value yields unsatisfactory results, the UP/DOWN buttons can be used to fine-tune the Gate, until it closes only during signal pauses and suppresses interference efficiently.

2.5 The Low Cut filter in the SHARK

In miking it is quite common to fade out low-frequency signal portions such as stage rumble, pop sounds or other types of interference. Frequencies of that kind often have high amplitudes and not only affect the sound image but can also damage power amps and/or loudspeakers. The SHARK is equipped with a tunable high pass filter that features a very high slope. Press the LOW CUT button to tune the cutoff frequency from 20 Hz through 150 Hz with the UP/DOWN buttons, so that interference noise is faded out as perfectly as possible, while the wanted signals remains unaffected.

2.6 The Compressor function

In broadcast and recording applications, signal levels often exceed the headroom of signal-processing devices, which means that the dynamic range must be reduced to avoid distortion. This is usually accomplished by the use of Compressors or Limiters, which use an automatic gain control circuit to reduce the signal level during loud passages. In this way, it is possible to compress the dynamics of a microphone channel

from 90 dB to 50 dB or less, which ensures the troublefree further processing of signals, e.g. in broadcast, stage or recording applications.

The Compressor monitors the program material using an adjustable threshold and continuous level control process, i.e. above threshold the signal gain is reduced, depending on threshold overshoot. Usually, the threshold is set to somewhere below the operating level to allow for a musical compression of the upper level range.

The DSP110 allows you to set two Compressor parameters. The first one, DENSITY, compresses the program material in a range from 0 (bypass) through 100 (max. compression). The second parameter, SPEED, allows you to adjust the Compressor function in the time domain. Here, you can set the control speed of the Compressor from 10 through 1000 msec. Use small values to make the Compressor respond to smallest level differences, and high values to process dynamics “inaudibly”.

3. INSTALLATION

3.1 Audio connections

As standard, the BEHRINGER DSP110 is installed with electronically servo-balanced inputs and outputs. The new circuit design features automatic hum and noise reduction for balanced signals and thus allows for trouble-free operation, even at high operating levels. Externally induced mains hum etc. will be effectively suppressed.

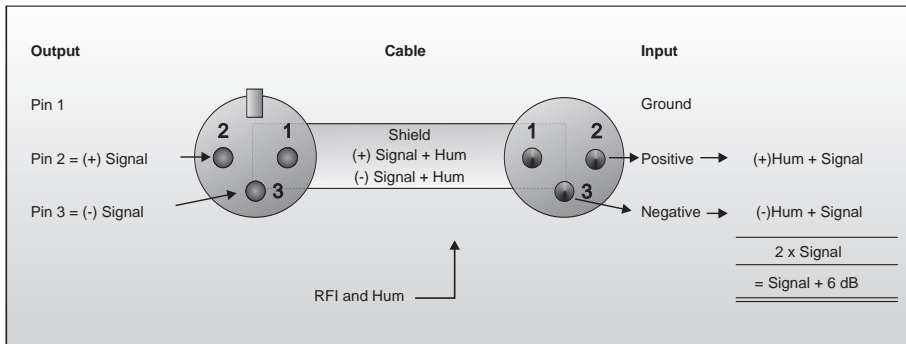

Fig. 3.1: Compensation of interference with balanced connections

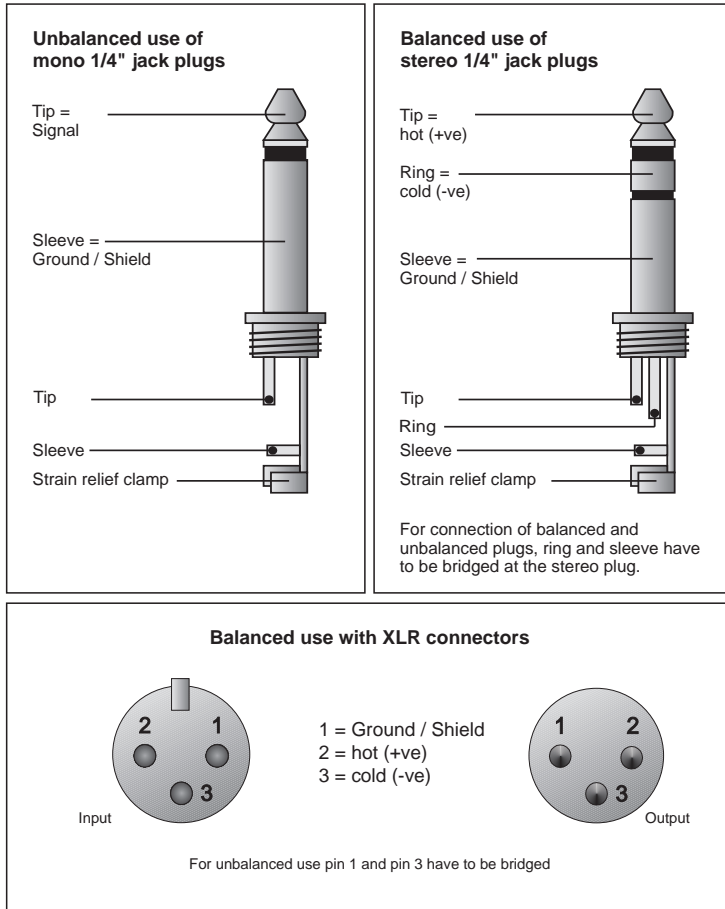

Fig. 3.2: Different plug types



Please ensure that only qualified persons install and operate the SHARK. During installation and operation the user must have sufficient electrical contact to earth. Electrostatic charges might affect the operation of the SHARK!

4. SPECIFICATIONS

AUDIO INPUTS

Connectors	XLR and 1/4" jack
Type	RF filtered, servo-balanced input
Impedance	6 kOhms balanced, 3 kOhms unbalanced
Nominal Operating Level	microphone or line level source (switchable)
Max. Input Level	+19 dBu at microphone level and line level

AUDIO OUTPUTS

Connectors	XLR and 1/4" jack
Type	electronically servo-balanced output stage
Impedance	60 Ohms balanced, 30 Ohms unbalanced
Nominal Operating Level	microphone level source or +4 dBu (switchable)
Max. Output Level	+20 dBu at +4 dBu nominal level, -12 dBu at microphone level

SYSTEM SPECIFICATIONS

Frequency Response	10 Hz to 21 kHz
Noise	> 92 dB at line level, unweighted, 22 Hz to 22 kHz > 89 dB at microphone level, unweighted, 22 Hz to 22 kHz
THD	0.007 % typ. @ +4 dBu, 1 kHz, gain 1

DIGITAL PROCESSING

Converters	24-bit Sigma-Delta, 64/128-times oversampling
Sampling Rate	46.875 kHz

DISPLAY

Type	4-digit numeric LED display
------	-----------------------------

POWER SUPPLY

Mains Voltages	USA/Canada	120 V ~, 60 Hz, PSU DSP110UL
	U.K./Australia	240 V ~, 50 Hz, PSU DSP110UK
	Europe	230 V ~, 50 Hz, PSU DSP110EU
	Japan	100 V ~, 60 Hz, PSU DSP110JP
	General export model	100 - 120 V ~, 200 - 240 V ~, 50 - 60 Hz

PHYSICAL

Dimensions (H * W * D)	approx. 2 1/4" (56 mm) x 3 1/2" (88 mm) x 5 1/8" (130 mm)
Net Weight	approx. 0.5 kg

BEHRINGER is constantly striving to maintain the highest professional standards. As a result of these efforts, modifications may be made from time to time to existing products without prior notice. Specifications and appearance may differ from those listed or illustrated.

5. RACKMOUNT (OPTIONAL)

With the available rackmount (optional) you have the possibility to place five SHARKs on two units of space in your rack.



Before you begin with the work, please disconnect the Power Supply Units from the SHARKs!

To mount the SHARKs on the rackmount you should use the supplied screws (type M3). You need two screws to fix one DSP110 onto the rackmount. In the bottom of your SHARK you will find two little threads. You have to position the single SHARKs on the rackmount, so that the threads correspond to the cutouts of the rackmount (see fig. 5.1). Now you can fix the DSP110 onto the rackmount. Just take a cross-point screwdriver and tighten both screws loosely. After you have fixed all SHARKs on the rackmount, you can adjust the devices and tighten all screws solidly.

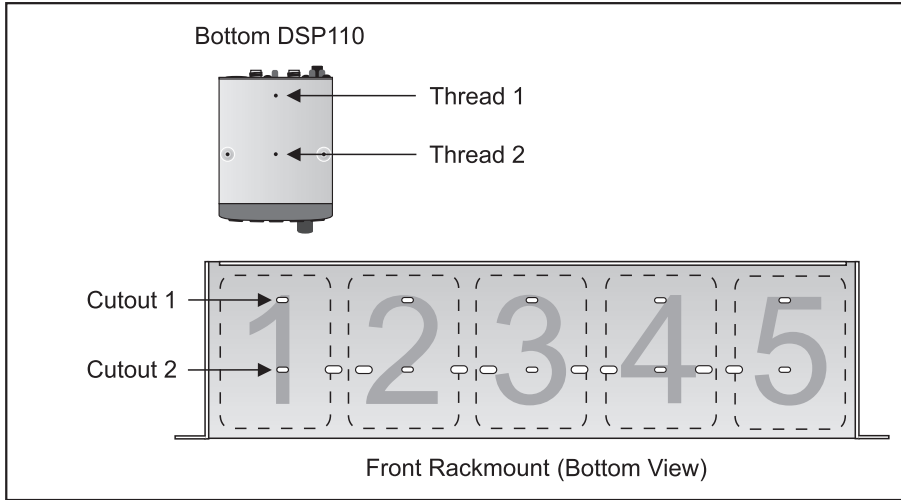

Fig. 5.1: Installation of the DSP110 on the available rackmount (optional)



Please, only use the supplied screws to install the SHARKs on the rackmount. Longer or thicker screws can damage the electronics inside of the device and doing so will void your warranty rights.

You will need 2 units of space for the DSP110 rackmount. For technical reasons a little gap remains above the rackmount.

6. WARRANTY

§ 1 WARRANTY CARD/ONLINE REGISTRATION

To be protected by the extended warranty, the buyer must complete and return the enclosed warranty card within 14 days of the date of purchase to BEHRINGER Spezielle Studioteknik GmbH, in accordance with the conditions stipulated in § 3. Failure to return the card in due time (date as per postmark) will void any extended warranty claims.

Based on the conditions herein, the buyer may also choose to use the online registration option via the Internet (www.behringer.com or www.behringer.de).

§ 2 WARRANTY

1. BEHRINGER (BEHRINGER Spezielle Studioteknik GmbH including all BEHRINGER subsidiaries listed on the enclosed page, except BEHRINGER Japan) warrants the mechanical and electronic components of this product to be free of defects in material and workmanship for a period of one (1) year from the original date of purchase, in accordance with the warranty regulations described below. If the product shows any defects within the specified warranty period that are not due to normal wear and tear and/or improper handling by the user, BEHRINGER shall, at its sole discretion, either repair or replace the product.

2. If the warranty claim proves to be justified, the product will be returned to the user freight prepaid.

3. Warranty claims other than those indicated above are expressly excluded.

§ 3 RETURN AUTHORIZATION NUMBER

1. To obtain warranty service, the buyer (or his authorized dealer) must call BEHRINGER (see enclosed list) during normal business hours **BEFORE** returning the product. All inquiries must be accompanied by a description of the problem. BEHRINGER will then issue a return authorization number.

2. Subsequently, the product must be returned in its original shipping carton, together with the return authorization number to the address indicated by BEHRINGER.

3. Shipments without freight prepaid will not be accepted.

§ 4 WARRANTY REGULATIONS

1. Warranty services will be furnished only if the product is accompanied by a copy of the original retail dealer's invoice. Any product deemed eligible for repair or replacement by BEHRINGER under the terms of this warranty will be repaired or replaced within 30 days of receipt of the product at BEHRINGER.

2. If the product needs to be modified or adapted in order to comply with applicable technical or safety standards on a national or local level, in any country which is not the country for which the product was originally developed and manufactured, this modification/adaptation shall not be considered a defect in materials or workmanship. The warranty does

not cover any such modification/adaptation, irrespective of whether it was carried out properly or not. Under the terms of this warranty, BEHRINGER shall not be held responsible for any cost resulting from such a modification/adaptation.

3. Free inspections and maintenance/repair work are expressly excluded from this warranty, in particular, if caused by improper handling of the product by the user.

This also applies to defects caused by normal wear and tear, in particular, of faders, potentiometers, keys/buttons and similar parts.

4. Damages/defects caused by the following conditions are not covered by this warranty:

- ▲ misuse, neglect or failure to operate the unit in compliance with the instructions given in BEHRINGER user or service manuals.
- ▲ connection or operation of the unit in any way that does not comply with the technical or safety regulations applicable in the country where the product is used.
- ▲ damages/defects caused by force majeure or any other condition that is beyond the control of BEHRINGER.

5. Any repair or opening of the unit carried out by unauthorized personnel (user included) will void the warranty.

6. If an inspection of the product by BEHRINGER shows that the defect in question is not covered by the warranty, the inspection costs are payable by the customer.

7. Products which do not meet the terms of this warranty will be repaired exclusively at the buyer's expense. BEHRINGER will inform the buyer of any such circumstance. If the buyer fails to submit a written repair order within 6 weeks after notification, BEHRINGER will return the unit C.O.D. with a separate invoice for freight and packing. Such costs will also be invoiced separately when the buyer has sent in a written repair order.

§ 5 WARRANTY TRANSFERABILITY

This warranty is extended exclusively to the original buyer (customer of retail dealer) and is not transferable to anyone who may subsequently purchase this product. No other person (retail dealer, etc.) shall be entitled to give any warranty promise on behalf of BEHRINGER.

§ 6 CLAIM FOR DAMAGES

Failure of BEHRINGER to provide proper warranty service shall not entitle the buyer to claim (consequential) damages. In no event shall the liability of BEHRINGER exceed the invoiced value of the product.

§ 7 OTHER WARRANTY RIGHTS AND NATIONAL LAW

1. This warranty does not exclude or limit the buyer's statutory rights provided by national law, in particular, any such rights against the seller that arise from a legally effective purchase contract.

2. The warranty regulations mentioned herein are applicable unless they constitute an infringement of national warranty law.

The information contained in this manual is subject to change without notice. No part of this manual may be reproduced or transmitted in any form or by any means, electronic or mechanical, including photocopying and recording of any kind, for any purpose, without the express written permission of

BEHRINGER Spezielle Studioteknik GmbH.

BEHRINGER, SHARK and FEEDBACK DESTROYER are registered trademarks. ALL RIGHTS RESERVED.

© 2001 BEHRINGER Spezielle Studioteknik GmbH.

BEHRINGER Spezielle Studioteknik GmbH, Hanns-Martin-Schleyer-Str. 36-38, 47877 Willich-Münchheide II, Germany

Tel. +49 (0) 21 54 / 92 06-0, Fax +49 (0) 21 54 / 92 06-30